

CE

**bycool!**  
green line

**COMPACT 1.4**



**Mercedes-Benz**

**AXOR (TR)**



**Instrucciones de Montaje**

*Mounting Instructions*

**Montaj Talimatları**

**ES** Spanish

**EN** English

**TK** Turkish

## Recomendaciones Para el montaje

- Antes de iniciar el montaje leer las instrucciones y seguirlas durante el proceso de instalación.
- Usar las herramientas adecuadas para cada operación.

## Electricidad

- Desconectar la llave de contacto.
- Desconectar la batería antes de empezar el montaje.
- Asegurar el conexionado de los componentes eléctricos, verificando su correcto encaje.

### **Atención**

Si durante el montaje el equipo se inclina ó se abate la cabina con el equipo montado, se deberá esperar un mínimo de 60 minutos, desde que el equipo quede horizontal, antes de ponerlo en marcha.

### **Atención**

Al instalar el equipo de aire acondicionado en el techo se debe proteger la parte superior de la cabina con un paño ó manta protectora para evitar posibles arañazos. Al instalar **Compact** en el techo hay que tener en cuenta que, normalmente, las cabinas que vienen provistas de escotilla, tienen una estructura suficiente para soportar el peso del equipo. Sin embargo, cuando no ocurra así y sea necesario realizar corte en el techo ó incluso si en el caso de llevar escotilla el material no es lo suficientemente resistente (caso de techo de fibra, plástico, etc...) es el instalador el que debe decidir, **bajo su responsabilidad**, sobre la necesidad de reforzar el techo para evitar posibles deformaciones, roturas, entradas de agua, etc... habilitando los medios para que esto no ocurra.

## Herramientas

Juego de Llaves Torx

Juego de Llaves Allen

Llave fija 10, 13, 14

Tijeras

Flexómetro

## Documentación incluida

Instrucciones de montaje	220.AA6.3091
Manual del usuario	220.AA6.0170
Diagnóstico de averías	220.AA6.0013
Listado de recambios	220.RE0.0175
Garantía	220.AA1.0017

## Simbología



Fragil





Atención corte!



Riesgo eléctrico

## **Advertencias**

 El personal instalador debe poseer una formación suficiente en Aire Acondicionado de vehículos.

 **dirna Bergstrom, s.l.** queda exenta de responsabilidad si se producen averías que procedan de una inadecuada manipulación ó instalación del equipo, ó por modificaciones y sustituciones efectuadas sin nuestra expresa autorización por escrito.

 **Equipo precargado con gas refrigerante. (No manipular el circuito de gas refrigerante).**

 Véase **procedimiento de garantía** del producto incluido en **Diagnóstico de Averías**.

 Véase **Manual de Usuario** del equipo para el correcto funcionamiento del mando a distancia y del panel de control.

 Al finalizar la instalación se debe entregar al usuario: **Manual del Usuario, Garantía y Diagnóstico de averías.**

 Antes de empezar con el montaje, montar rejilla entrada aire delantera.



**1** En caso de llevar spoiler presentar plantilla y cortar.

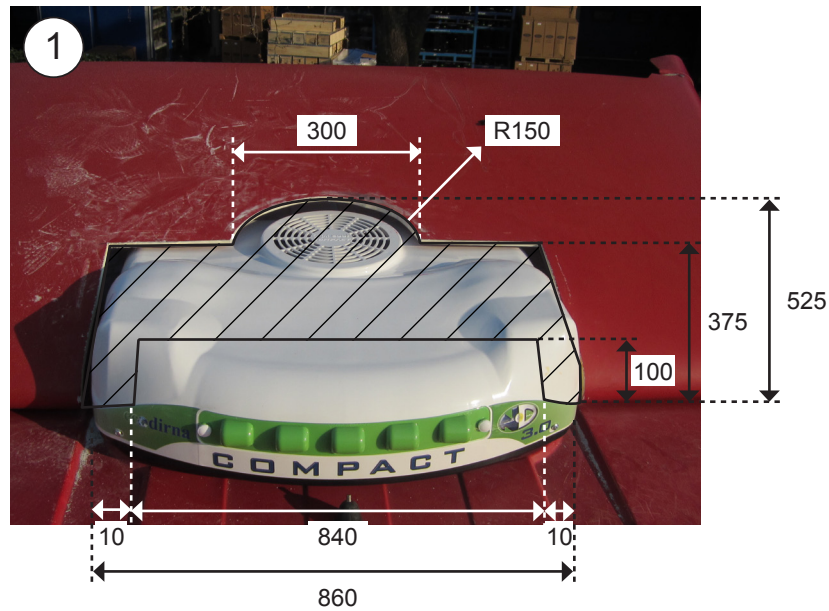

**2** Desmontar tapa escotillas los elementos de fijación y entregar éstos al cliente.



3

Quitar los residuos sobrantes adheridos al techo antes de pegar la junta EPDM.



3



4

Pegar junta EPDM alrededor del hueco de escotilla (mirar el detalle para cortar los bordes finales de unión de la junta).

4



**COMO CORTAR LA JUNTA EPDM PARA EVITAR FILTRACIÓN DE AGUA EN LA CABINA**

A- Pegar la junta, manteniendo 100 mm de papel protector por cada lado.

B- Quitar los dos piezas de papel.

C- Pegue presionado ambos finales.

(A)

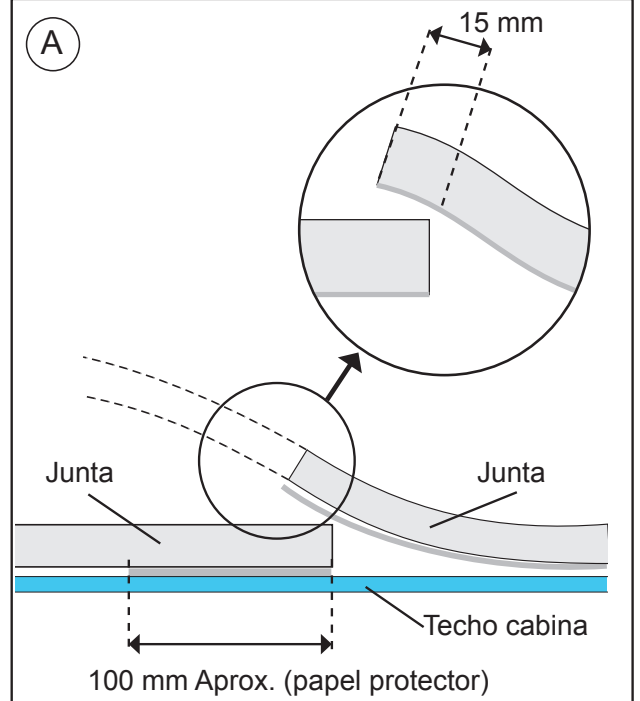

(B)

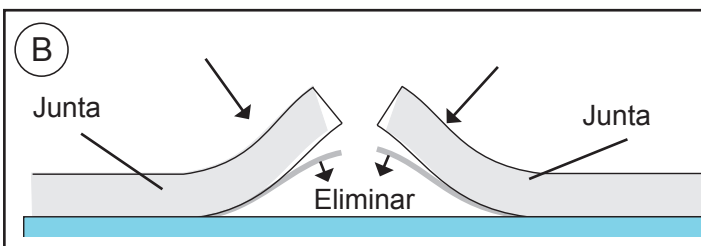

(C)

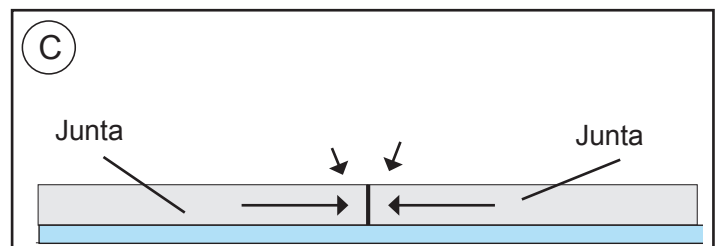

**5** **EXTERIOR CABINA:**  
Posicionar el Compact en el hueco de la escotilla.

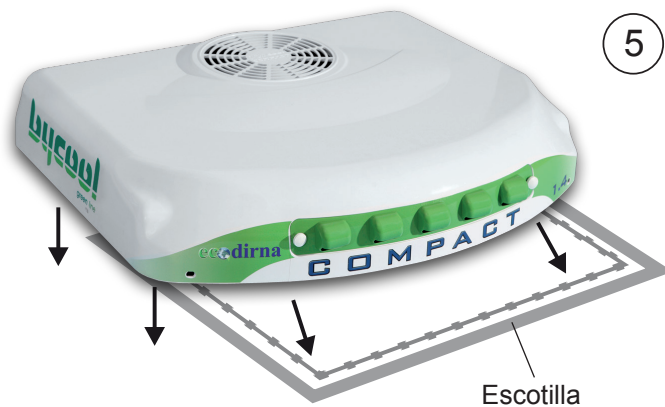

 ¡Atención! Al colocar el equipo en hueco escotilla, verificar que las salidas de desagüe no queden obstruidas por la junta EPDM.



**6** Colocar canalizador gomaespuma quedando la parte más blanda en la base del equipo.



**7** **INTERIOR CABINA:**  
Roscar 10 mm aproximadamente (4) espárragos 8/125x70 con arandela goma, arandela plana, tuerca y apretar.

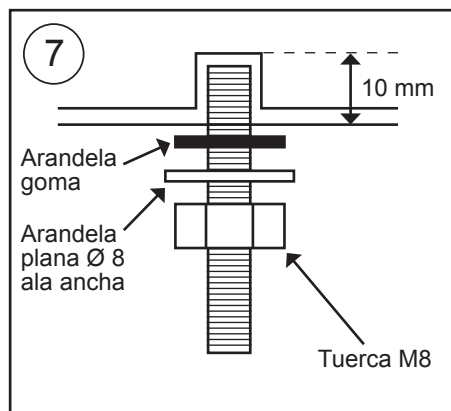
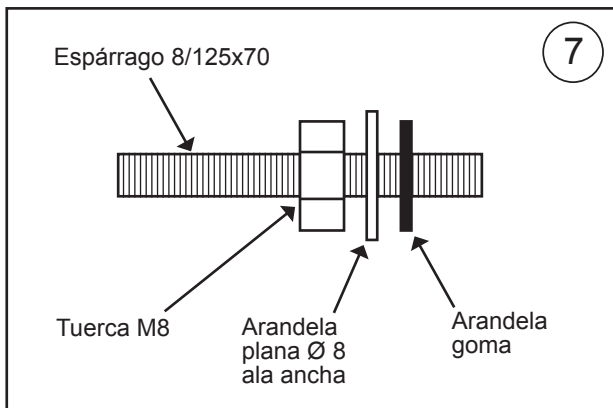

**8** Colocar soporte fijación colocando (2) arandelas planas entre éste y colocar tuerca autoblocante, sin llegar a apretar.

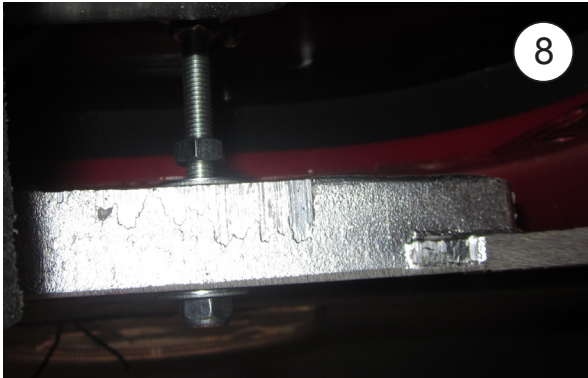
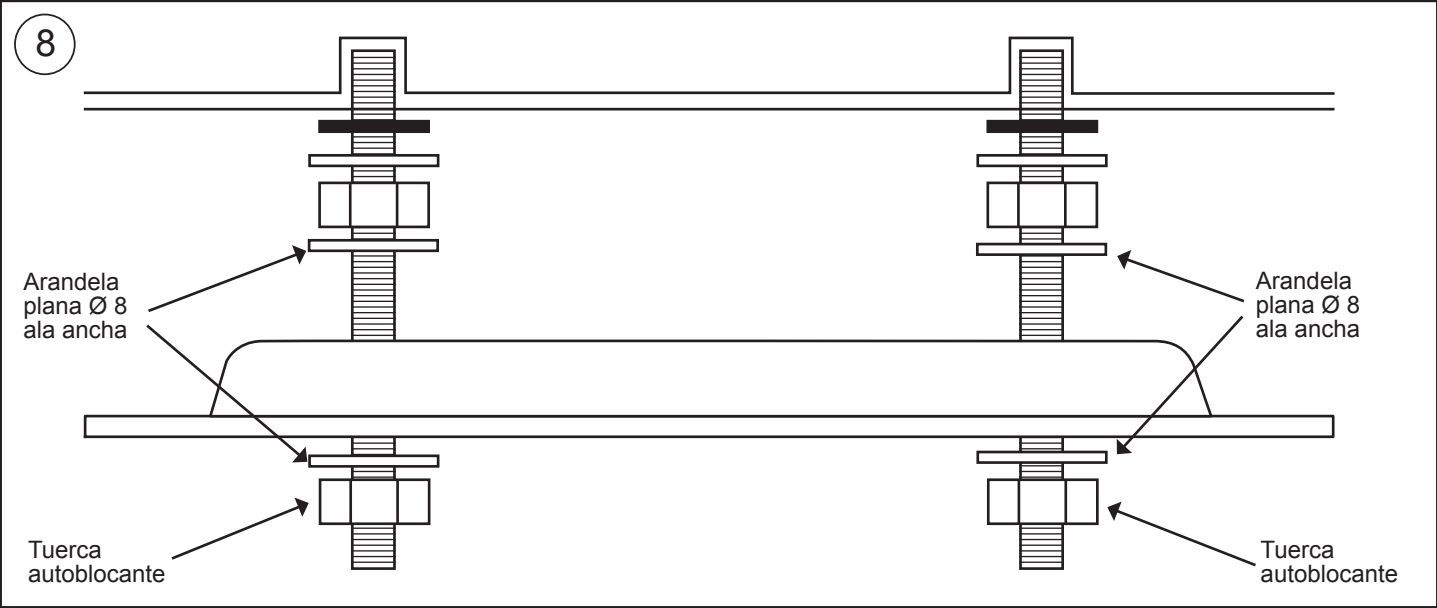

**9** Roscar 10 mm (4) espárragos M6 x 80, donde se indica con arandela goma, arandela plana ala ancha, tuerca M6 y apretar.

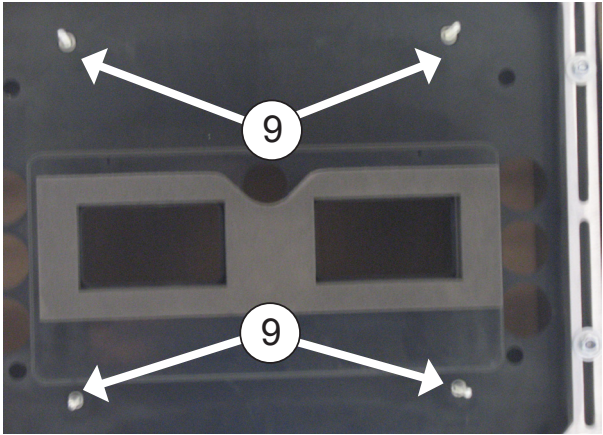
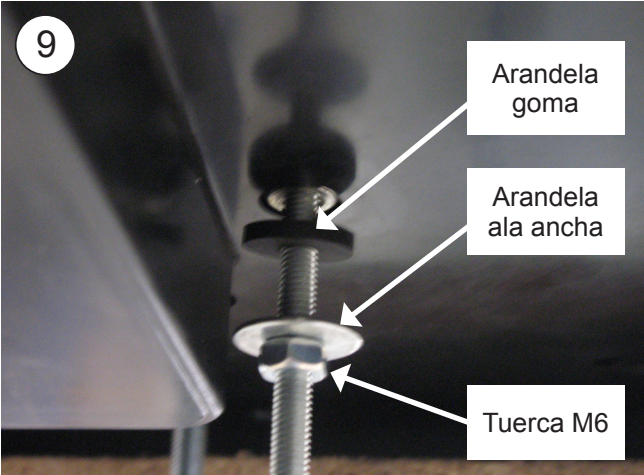

10

Colocar (1) tuerca M6 **sin apretar** en cada espárrago .

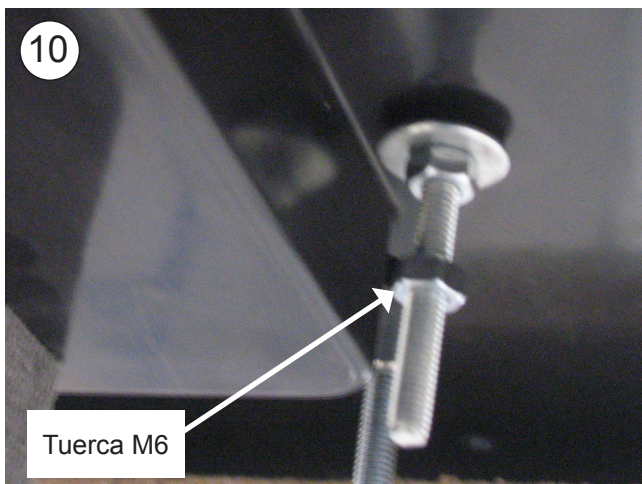

11

Conectar las (2) cajas de 4 vías y (4) de 2 vías; del panel interior de distribución de aire con las del **Compact**.

**Atención:** Es muy importante no invertir los colores de la caja de 2 vías del ventilador del condensador (caja con cables R y N).

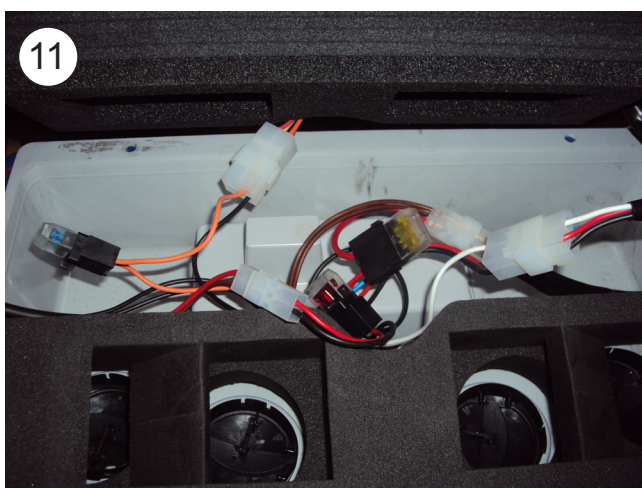

12

Introducir cableados en el hueco existente (H) en el panel interior de distribución de aire para no interferir en el ajuste de los canalizadores con la base del equipo.

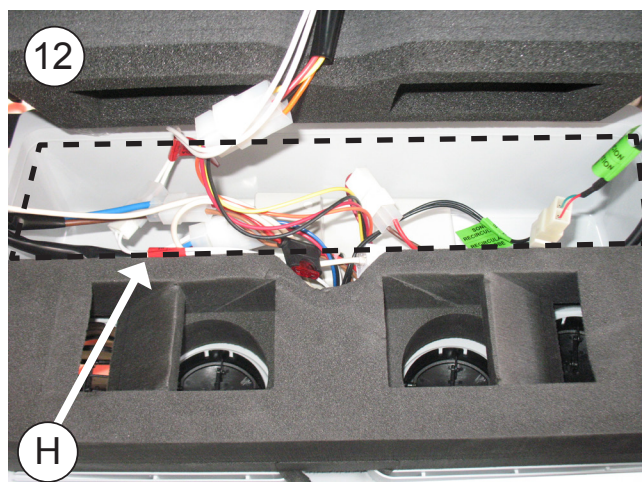

**13** Colocar panel interior de distribución de aire en los espárragos anteriores con 1 tuerca M6, 1 arandela Ø 6 ala ancha y fijar con hexágono L=25 y apretar.

**Nota:** El hexágono debe quedar 1 mm por encima del tapizado.

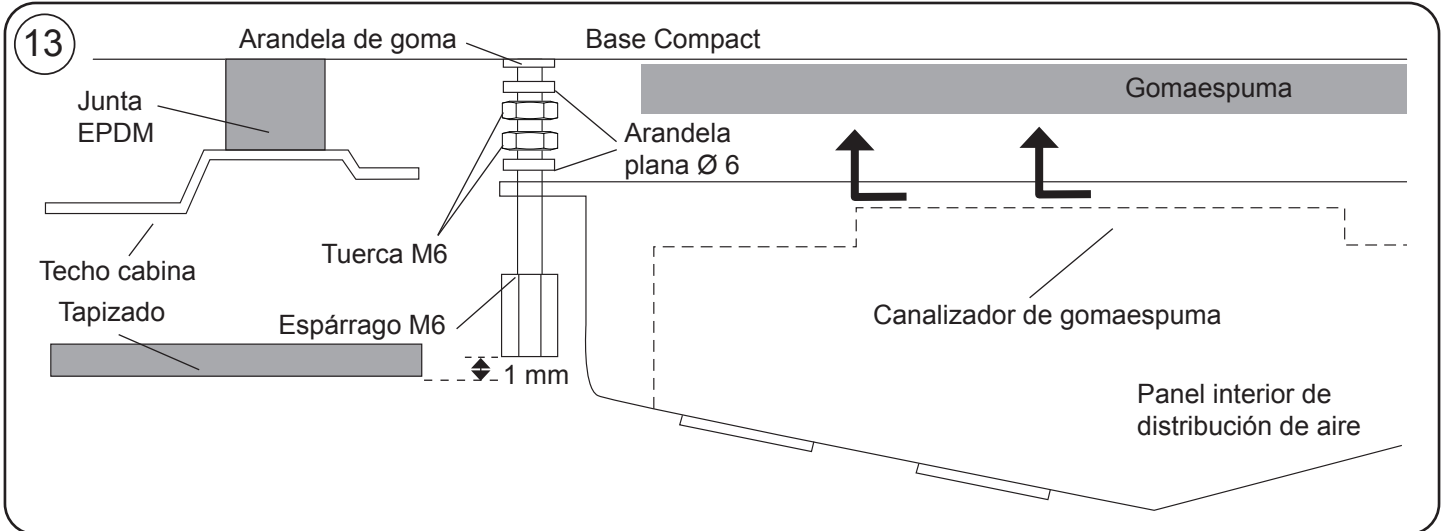

**14** Apretar tuerca del punto 10 hasta hacer tope con la parte superior del panel interior de distribución de aire.

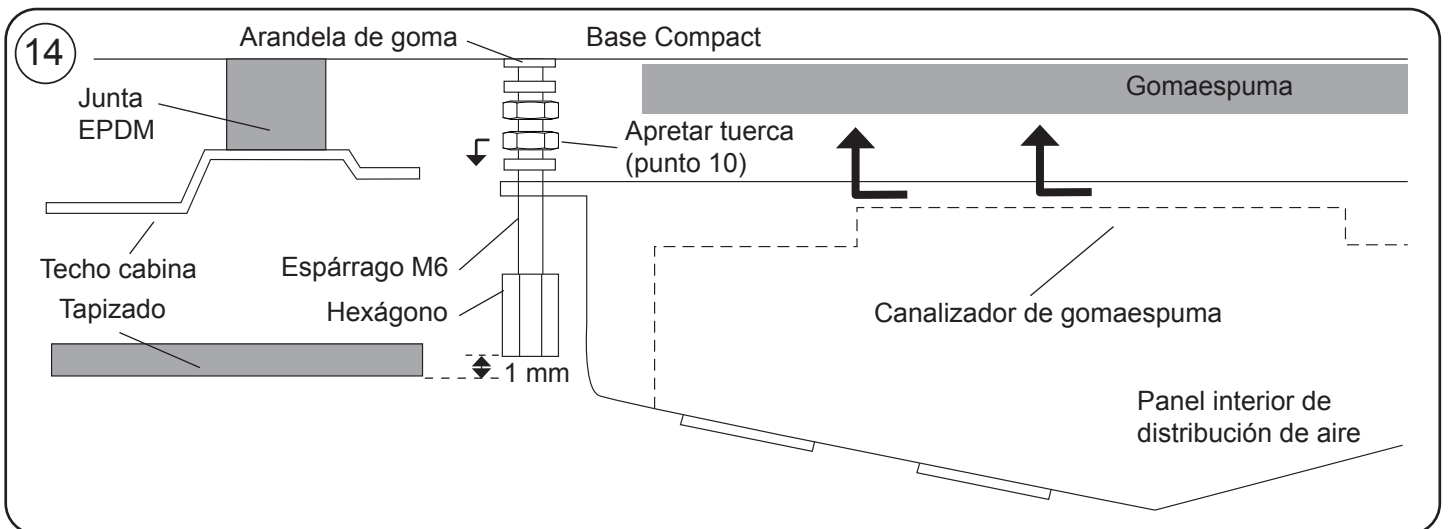

**15** Presentar consolas y centrar el equipo. Una vez centrado quitar consola.





**16** Fijar los soportes de sujeción apretando las tuercas autoblocantes hasta hacer tope con la tuerca superior.

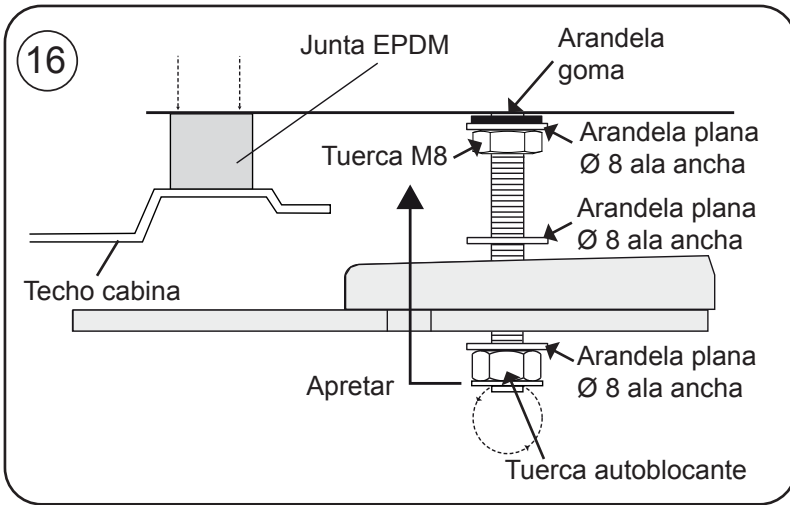
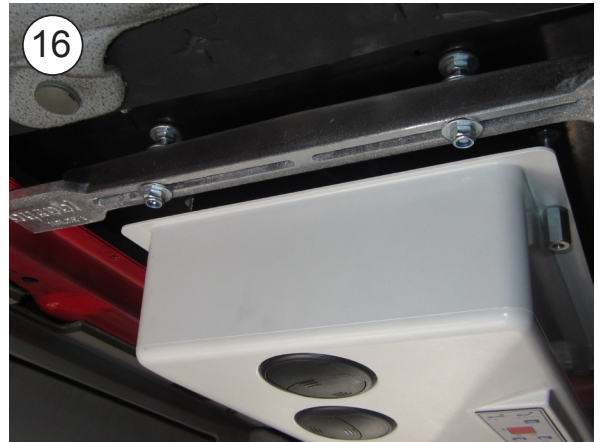

**17** Colocar consola plana, a continuación colocar la otra consola y fijar con (4) tornillos allen M6/100x15.

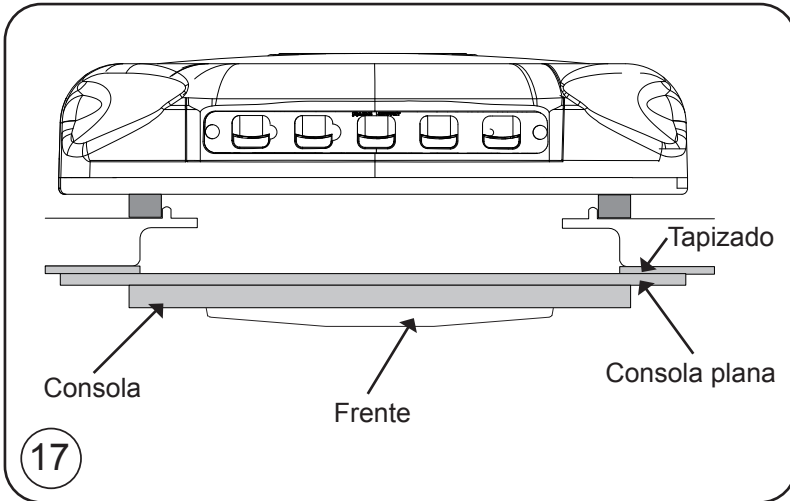

**18** Cubrir los (4) tornillos M6/100x15 allen con los embellecedores redondos de M6 de plástico.



## INSTRUCCIONES DETALLADAS SOBRE LA INSTALACIÓN DEL CABLEADO DE ALIMENTACIÓN

1

Conectar cableado al equipo y llevarlo a la parte trasera del camión por la parte izquierda.



2

Fijar cableado con soportes de plástico adhesivos y bridas. Conectar cableado con cableado batería (A).

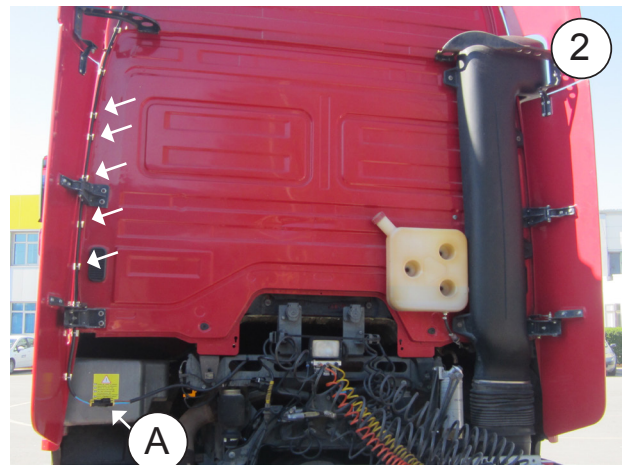

3

Abatir cabina y pasar cableado por la inferior de la misma a través del paso original de cables.



## INSTRUCCIONES DETALLADAS SOBRE LA INSTALACIÓN DEL CABLEADO DE ALIMENTACIÓN

**4**

Llevar cableado a batería por paso cableados original y conectar cable azul (+) y cable marrón (-).

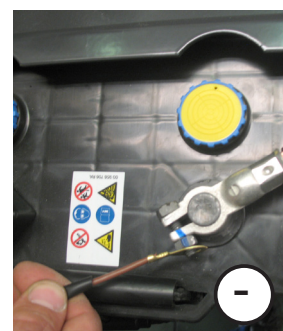
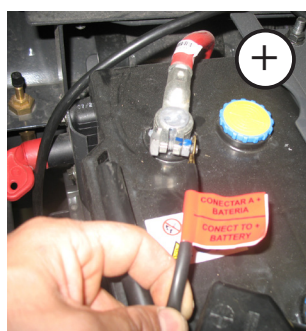

**AL CONECTAR EL CABLEADO, DEJAR LA DISTANCIA ADECUADA ,PARA EVITAR SU ROTURA POR LOS MOVIMIENTOS DE LA CABINA.**

**IMPORTANTE:** Debido al complejo sistema de regulación electrónica del equipo, la toma de corriente debe realizarse directamente a la batería del vehículo.

**IMPORTANTE:** Para la puesta en marcha consultar el Manual del Usuario.

# Esquema eléctrico

## ¡AVISO IMPORTANTE!

**Precaución** de no invertir las polaridades al conectar el equipo. Si esto sucediera, la placa de mandos no se enciende y el equipo no funciona.

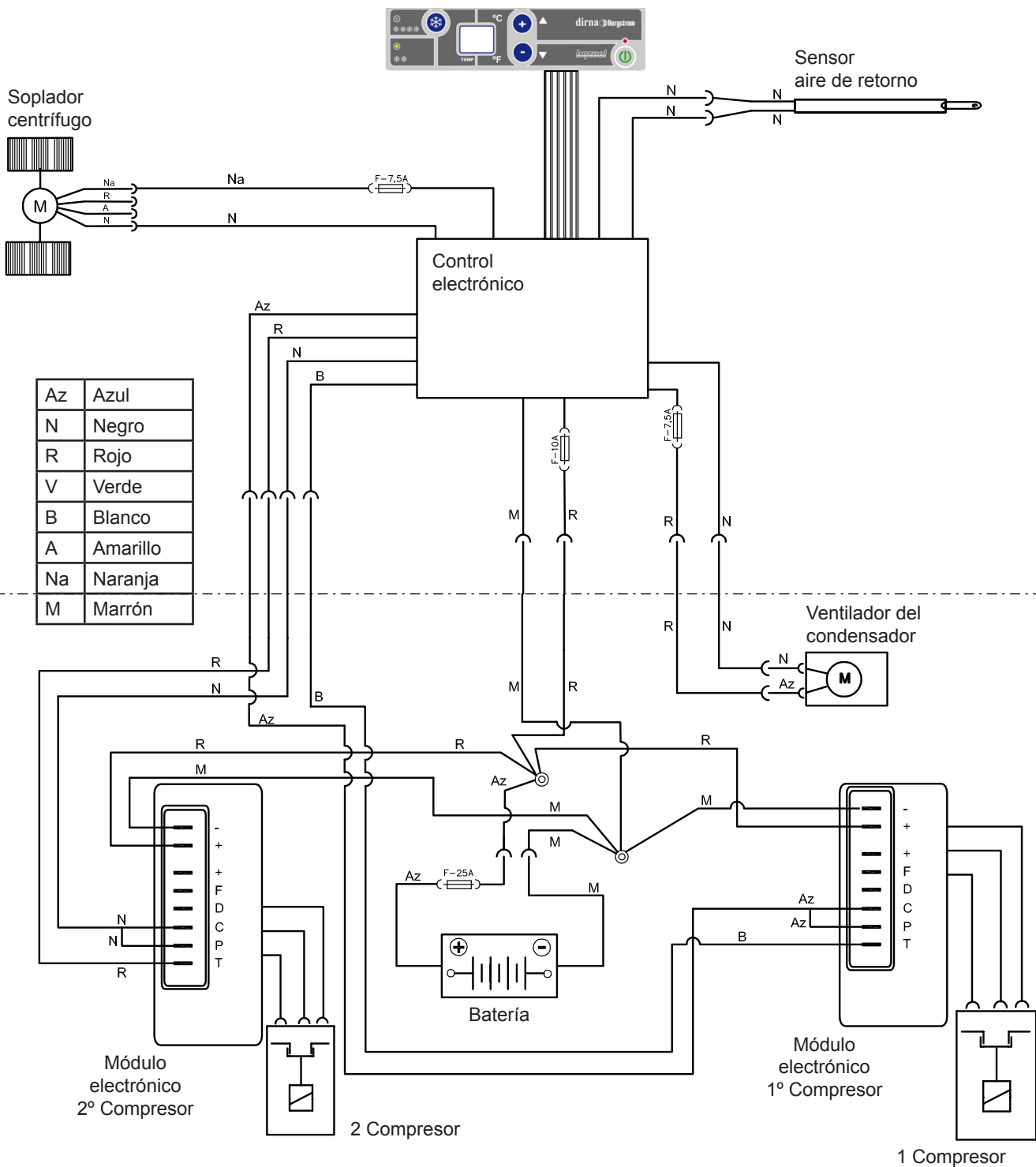

### Assembly Recommendations

- Before starting assembly, please read instructions and follow them during installation process.
- Use the adequate tools for each operation.

### Electricity

- Disconnect ignition key.
- Disconnect battery before starting assembly.
- Make sure electric components are securely connected, checking their correct fitting.

### Warning

If the unit slants during assembly, wait for at least 60 minutes with the unit in horizontal position before starting it up.

### Warning

When installing air conditioning equipment on roof, the upper cabin part must be protected with a cloth or a protective blanket to avoid possible scratches. When installing **Compact** on roof, take into account that, normally, cabins equipped with a hatch have a strong enough structure to hold equipment weight. However, if it is not the case and it is necessary to carry out a cut in the roof or, although it has a hatch, the material is not resistant enough (*if roof is made of fibre, plastic, etc...*), it is the installer who will have to decide, under his responsibility, if it is necessary to reinforce the roof to avoid possible deformations, breaks, water entries, etc., habilitating the means required to stop it from occurring.



### Tools

- Torx wrenches set
- Allen wrenches set
- Open-jawed spanner 10, 13, 14
- Scissors
- Flexo-meter







### Documentation included

Mounting instructions	220.AA6.3091
User's guide	220.AA6.0170
Troubleshooting	220.AA6.0013
Included parts	220.RE0.0175
Warranty	220.AA1.0017

### Symbology

-  Fragile
-  Beware of cuts!
-  Electrical hazard

### Warnings

-  The installing personnel must have a sufficient training in vehicles air conditioning.
-  **dirna Bergstrom, s.l.** shall not be responsible for breakdowns or damages coming from an inadequate handling or installation of the equipment or from modifications and substitutions carried out without our express and written authorisation.
-  **Equipment pre-charged with refrigerating gas. (Do not handle refrigerating gas circuit).**
-  Please see product **warranty procedure** included in **Troubleshooting**.
-  Please see equipment **User's Guide** for its correct functioning of the remote control and control panel.
-  Once installation is finished, the following documents must be handed over to the user: **User's Guide, Warranty and Troubleshooting**.



Mount the front air input grille before starting assembly.



1

If a spoiler is fitted, position the template and cut.

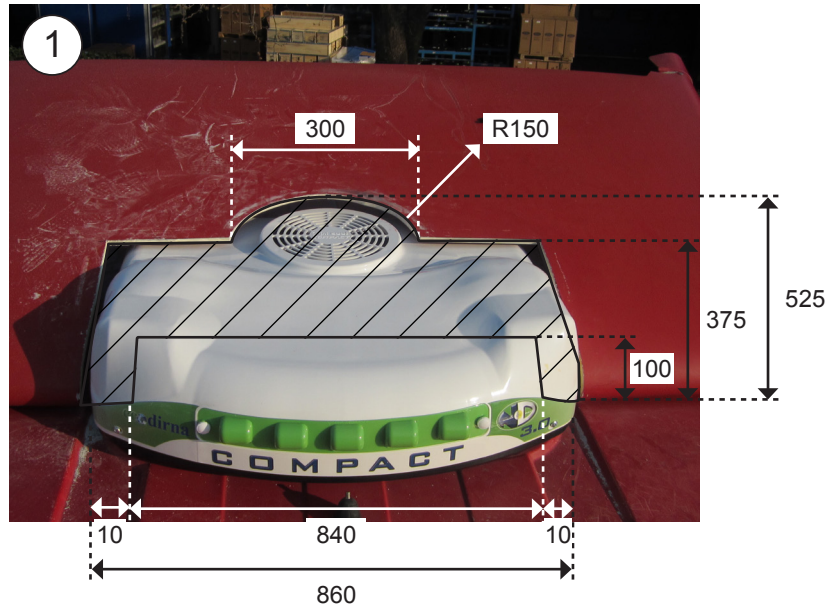

2

Take down the hatch cover and the attachment elements, and hand them over to the customer.



**3** Remove any excess on the ceiling before attaching the EPDM seal.



**4** Attach the EPDM seal around the hatch gap (see the details to cut the ends of the seal joint).



 **HOW TO CUT EPDM GASKET TO AVOID WATER FILTRATION INTO THE CABIN**

**A-** Glue gasket, keeping 100 mm of protection paper at each side.

**B-** Remove the two pieces of paper.

**C-** Glue by pressing both ends.

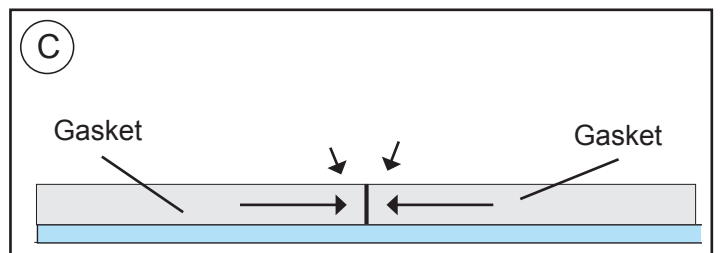
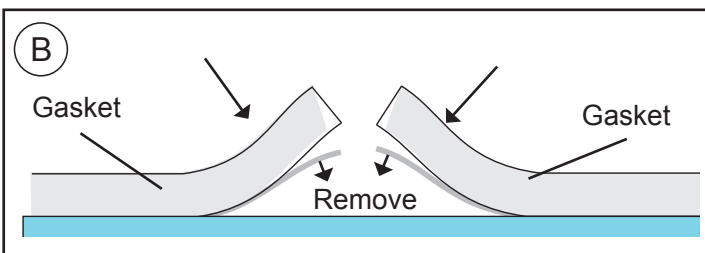
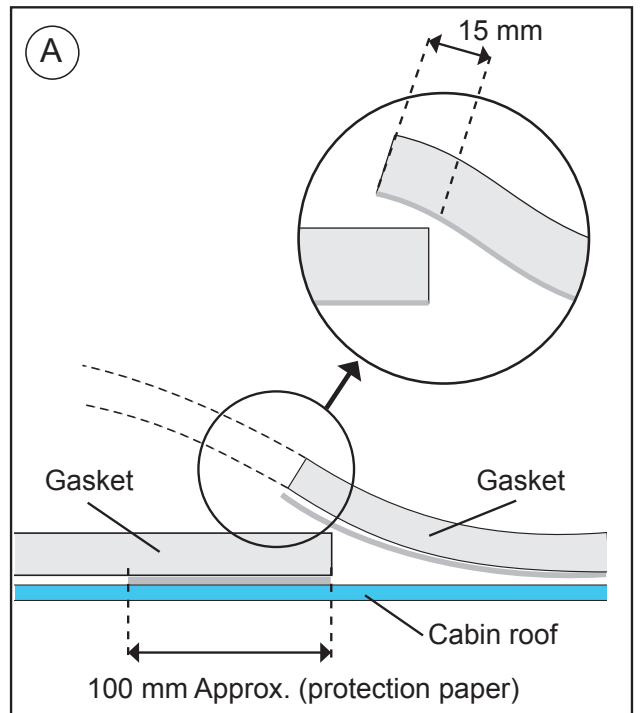

**5 CABIN EXTERIOR:**  
Position the Compact in the hatch gap.

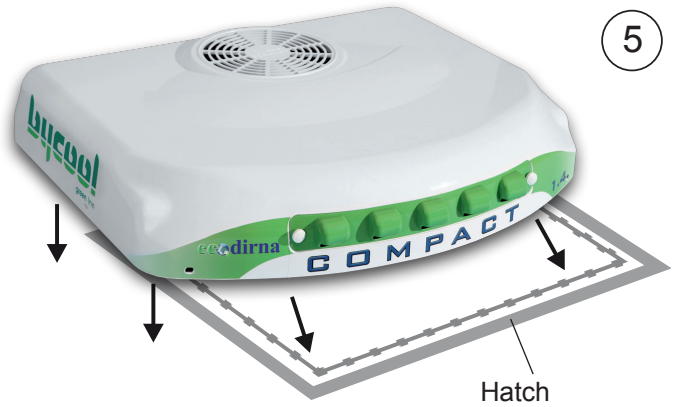

**Caution!** When positioning the unit above the hatch gap, check that the wastewater run-offs are not blocked by the EPDM seal.



**6** Position foam rubber, ensuring the softest part is placed on the base of the unit.



**7 CABIN INTERIOR:**  
Screw on (4) 8/125x70 studs approximately 10 mm with rubber washer, flat washer and nut, and tighten.

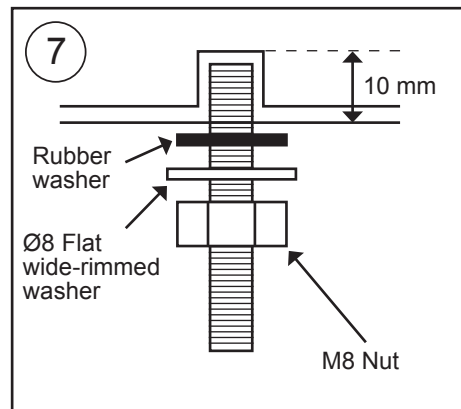
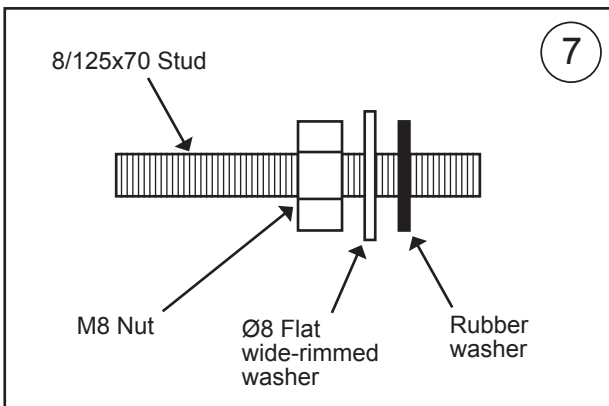



**8** Position the attachment support by inserting (2) flat washers and position a self-locking nut, without tightening completely.

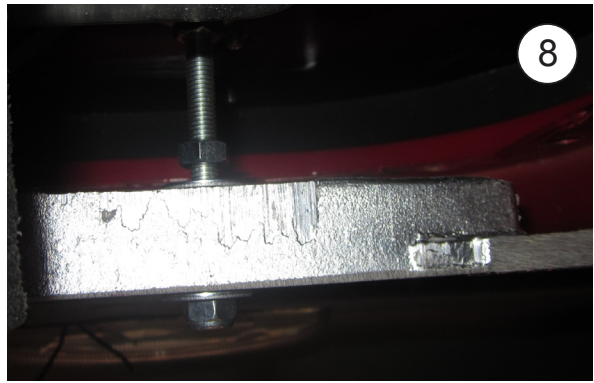
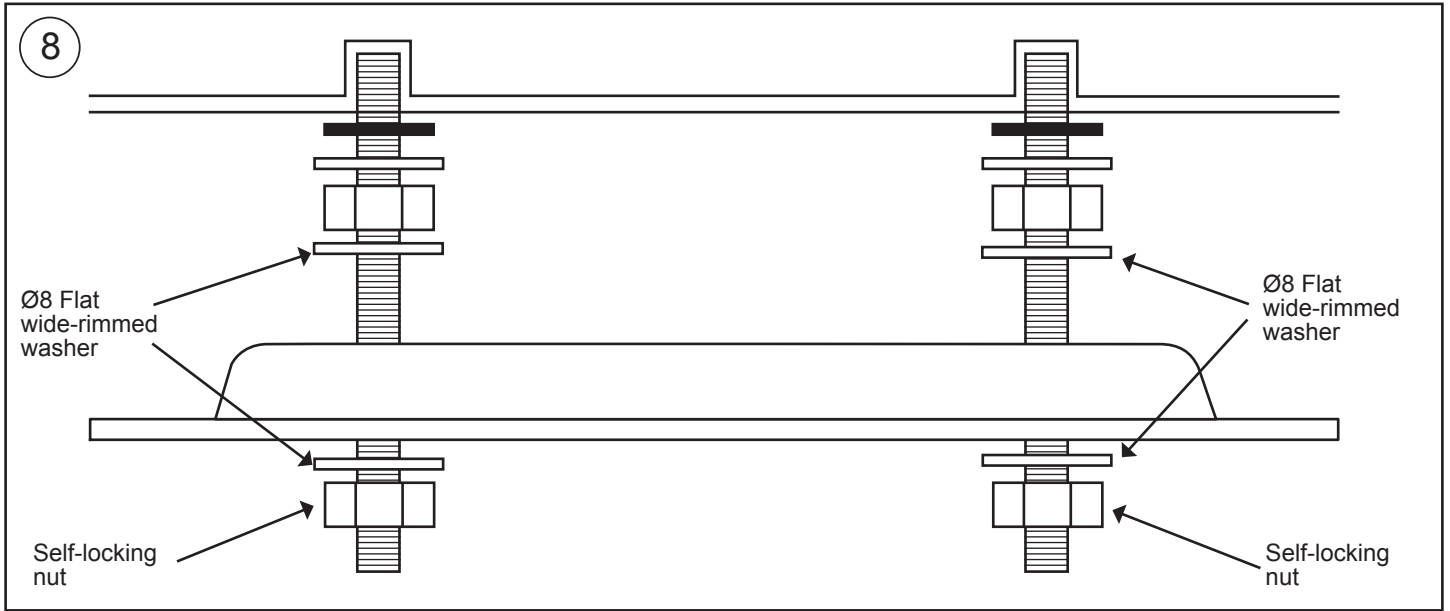

**9** Screw (4) M6x80 studs 10 mm as indicated with rubber washer, flat wide-rimmed rubber washer and M6 nut, and tighten.

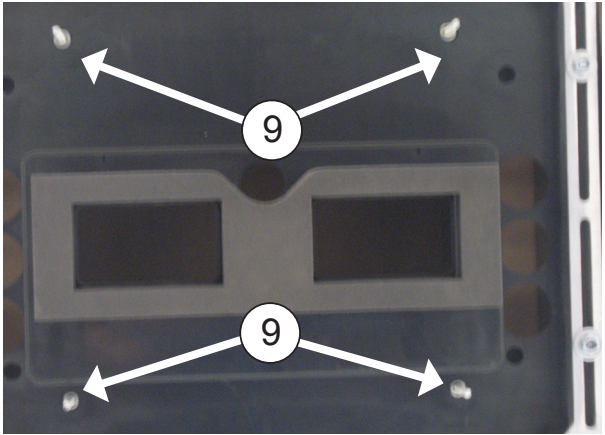
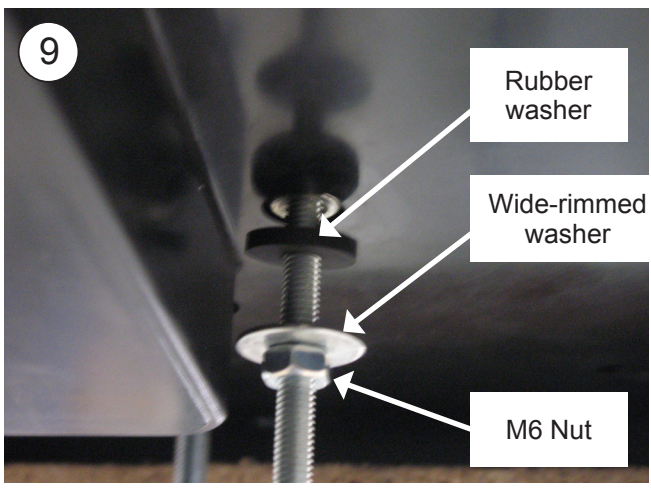

**10** Position (1) M6 nut **without tightening** on each stud.

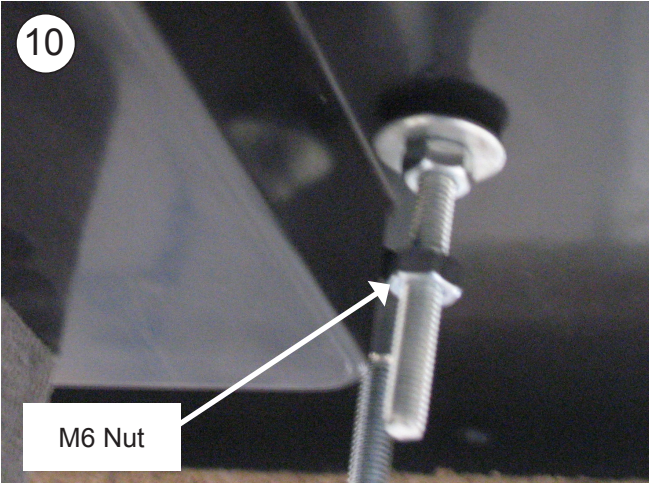

**11** Connect the (2) 4-way box and (4) 2-way box of the interior air distribution panel to those of the **Compact**.  
**NOTE:** It is very important not to invert the colours of the condenser fan 2-way box (box with R and N wires).



**12** Introduce the cabling in the gap (H) in the interior air distribution panel in order not to interfere in the adjustment of the ducts with the base of the unit.

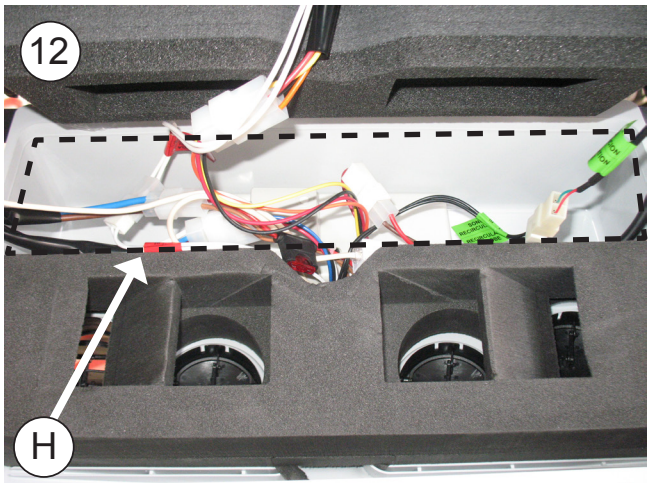

**13** Position the interior air distribution panel on the front studs with 1 M6 nut, 1 Ø6 wide-rimmed washer and secure with L=25 hexagon and tighten.

**Note:** The hexagon must be 1 mm above the upholstery.

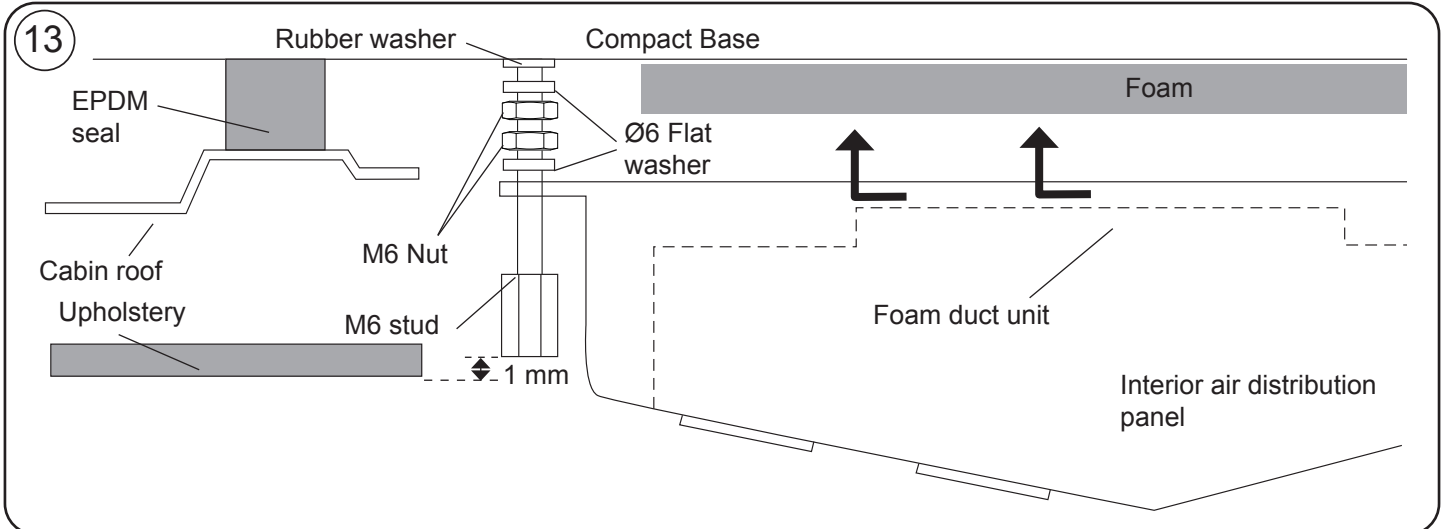

**14** Tighten the nut in point 10 until it comes up against the top part of the interior air distribution panel.

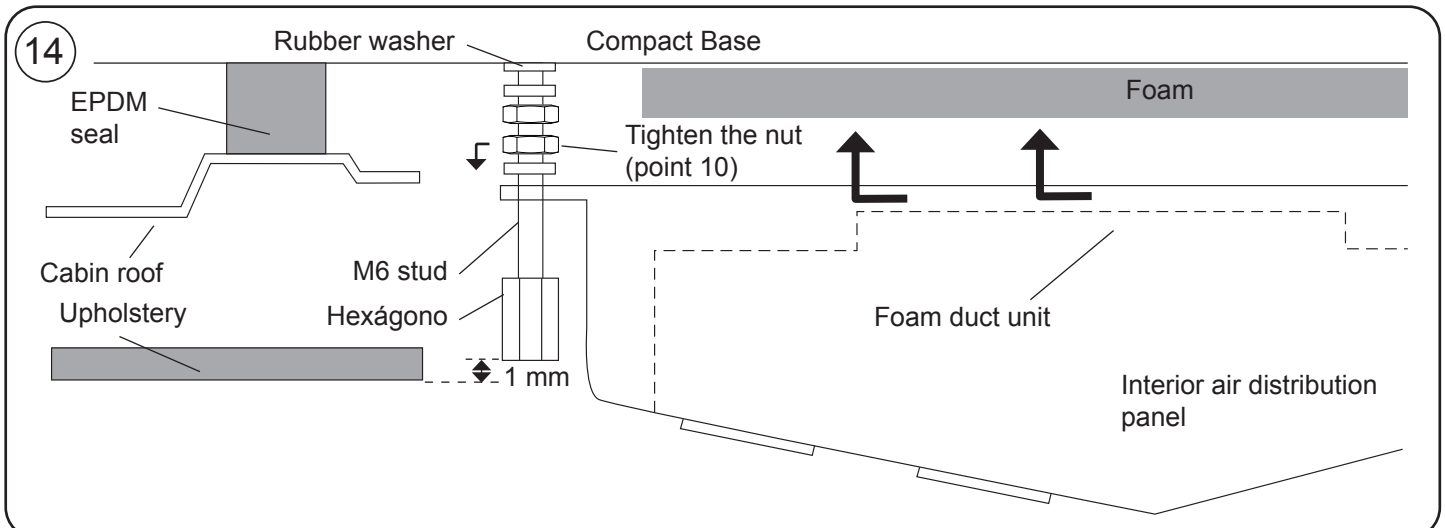

**15** Position the consoles and align the unit. Once aligned, remove the console.



**16** Secure the attachment support pieces by tightening the self-locking nuts until they come up against the upper nut.

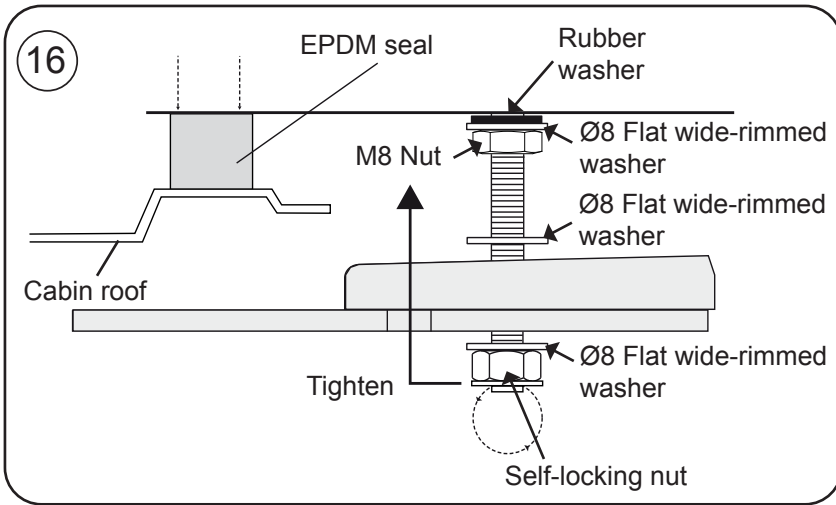
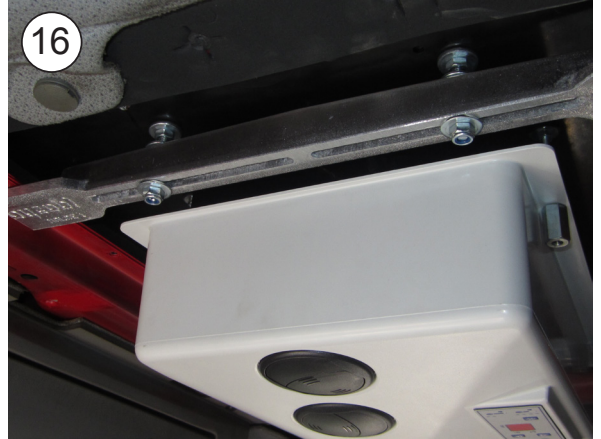

**17** Position the flat console, then position the other console and secure with (4) M6/100x15 Allen screws.

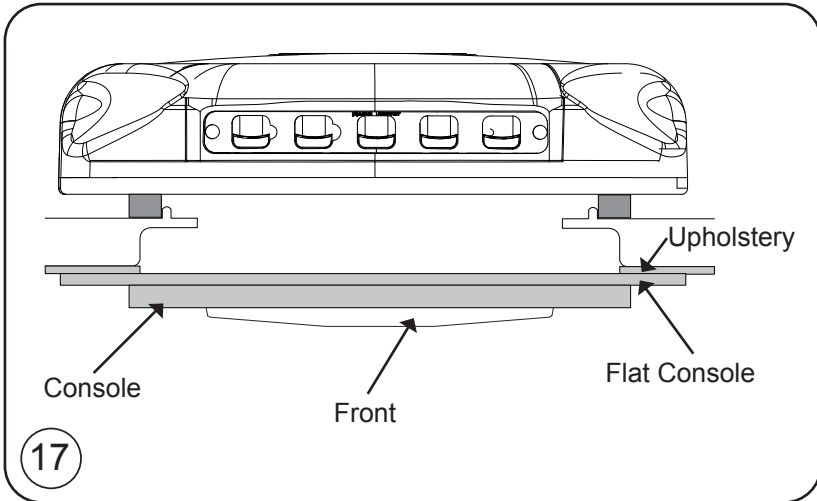

**18** Cover the (4) M6/100x15 Allen screws with the M6 round plastic decorative pieces.



**DETAILED INSTRUCTIONS  
 ON INSTALLING POWER CABLES**

**1** Connect the cabling to the unit and run to the left to the back part of the truck.



**2** Secure the cabling with adhesive plastic support pieces and flanges. Connect the cabling to the battery cabling (A).



**3** Fold cabin wiring and move the bottom of the original using the same feedthrough.



**DETAILED INSTRUCTIONS  
 ON INSTALLATING POWER CABLES**

**4** Take the battery cabling through the original cabling run and connect the blue wire (+) and brown wire (-).

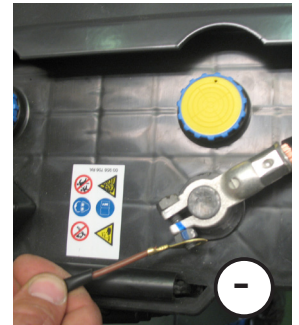
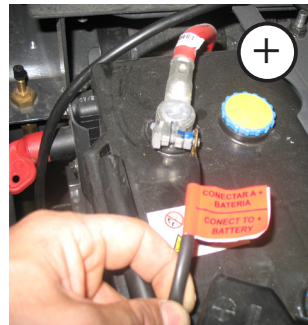

**WHEN CONNECTING THE CABLE, LEAVE SUITABLE DISTANCE IN ORDER TO PREVENT BREAKAGE WHEN THE CABIN MOVES.**

**IMPORTANT:** Due to the unit's complex electronic regulation system, the power connection must be made directly to the vehicle's battery.

**IMPORTANT:** Check the User Manual before starting up.

Electric wiring

**IMPORTANT WARNING!**

**Take care** not to invert the polarities when connecting the equipment to the battery. If this happens, the plate does not come on and the unit does not work.

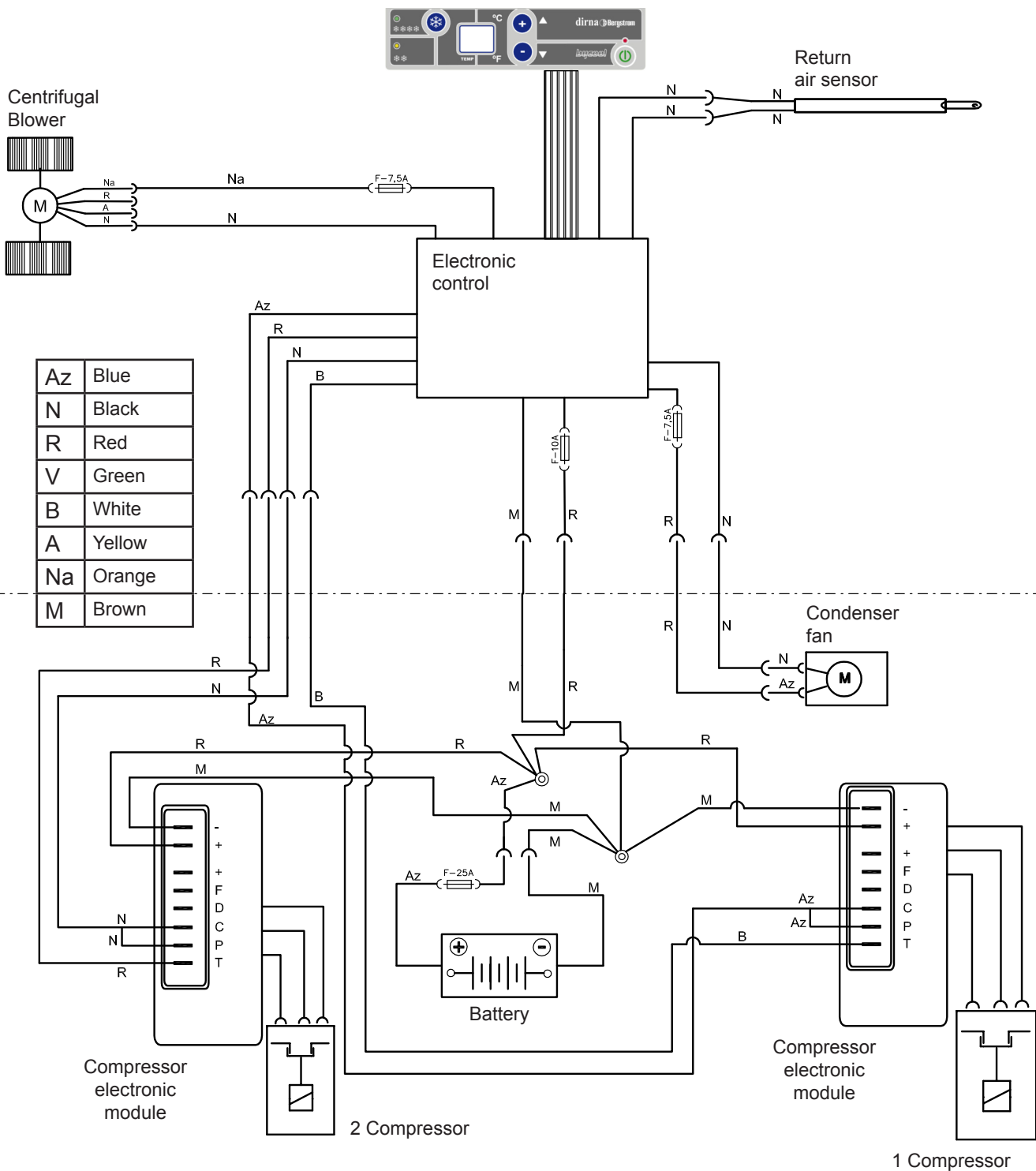

## Montaj için Tavsiyeler

- Montaja başlamadan önce talimatları okuyun ve kurulum işlemi süresince bunlara uyun.
- Herbir işlem için uygun alet-edevatları kullanın.

## Elektrik

- Kontak anahtarını kapatın.
- Montaja başlamadan önce batarya bağlantısını kesin.
- Elektrik bileşenlerinin bağlantılarının uygun şekilde olmasını sağlayın.

## ⚠ Dikkat

Montaj sırasında cihaz eğim alırsa ya da kabin ile monte edilen cihaz kapandığında, çalıştırmadan önce cihazın yatay durması için en az 60 dakika beklenmelidir.

## ⚠ Dikkat

Klima cihazını kabinin üstüne monte ederken, kabinin üst tarafı bir pano ya da koruyucu bez ile olası çizilmelere karşı korunmalıdır. **Compact'**ı kabinin üstüne monte ederken normalde kabin kaportasının cihazı destekleyecek yeterli yapısal dirence sahip olduğu dikkate alınmalıdır. Ancak, durumun bu şekilde olmaması halinde, kabinin üstünde kesim yapılmasının gerekli olması durumunda ya da malzemenin yeteri kadar sağlam olmaması durumunda (kabin tavanının elyaf, plastik vb. yapılmış olması...) olası deformasyonları, kırılmaları, su girmesini önlemek, kabin çatısını güçlendirmek, kurulumu yapanın sorumluluğu altındadır.

## Araç gereçler

Torx anahtar takımı

Allen anahtar takımı

Anahtar 10, 13 14

Makaslar

Fleksometre

## İlgili dokümantasyonlar

Montaj talimatları	220.AA6.3091
Kullanım kılavuzu	220.AA6.0170
Arıza teşhisi	220.AA6.0013
Yedek parça listesi	220.RE0.0175
Garanti	220.AA1.0017

## Semboller



Kırılabilir



Dikkat kesebilir!



Elektrik çarpma tehlikesi

## ⚠ Uyarılar



Kurulumu yapan kişi, araç klimaları konusunda yeterli bir eğitimden geçmiş olmalıdır.



**dirna Bergstrom, s.l.** bozulmaların cihazın uygunsuz manipülasyon ya da yanlış kurulumundan kaynaklanması ya da modifikasyon ve değişikliklerin şirketimizin yazılı izni olmadan yapılması durumunda ortaya çıkabilecek olumsuzluklardan sorumlu tutulamaz.



**Cihaza önceden soğutucu gaz yüklenmiştir.** (Soğutucu gaz devreleri manipüle edilmemelidir).



**Arıza Teşhisi** dahil **garanti sürecine** bakınız.



Uzaktan kumandanın ve kontrol panelinin doğru çalıştırılması için **Kullanım Kılavuzuna** bakınız.



Kurulumdan sonra kullanıcıya şunlar sunulmalıdır: **Kullanım Kılavuzu, Garanti ve Arıza teşhisi.**





Rüzgarlığın olması durumunda şablon çerçeve kesilir.



1

Rüzgarlığın olması durumunda şablon çerçeve kesilir.

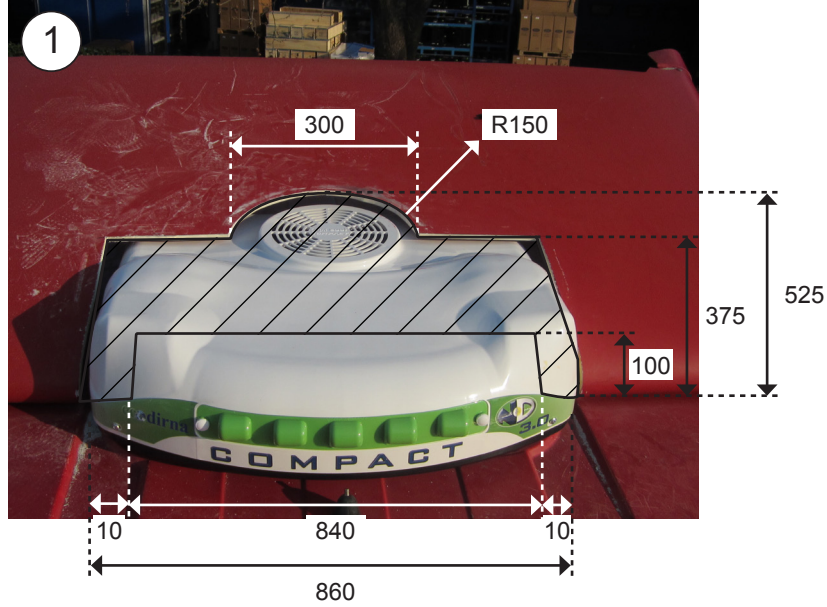

2

Kapağı ve sabitleme elemanlarını çıkarın ve müşteriye sunun.

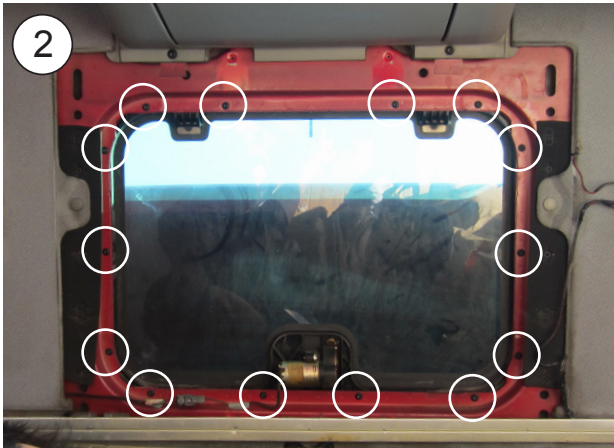

- 3** EPDM contasını takmadan önce kabin çatısındaki kalıntıları çıkartın.



- 4** EPDM contasını kapak ağzına takın (contanın son sınırlarını görmek için ilgili ayrıntıya bakınız).



#### KABİNE SU GİRİŞİNİ ENGELLEMEK İÇİN EPDM CONTASI NASIL KESİLMELİDİR

- A-** Contayı yapıştırın, her bir tarafta 100 mm kağıt koruyucuyu tutun.
- B-** Kağıdın her iki parçasını çıkarın.
- C-** Her iki ucu yapıştırın.

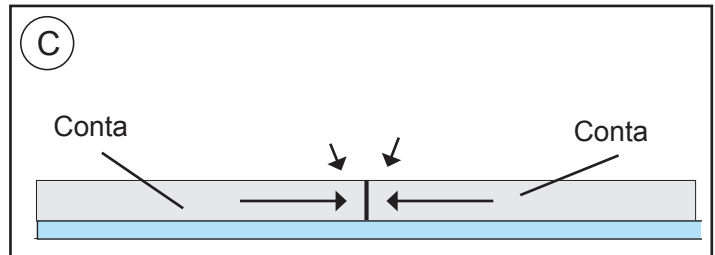
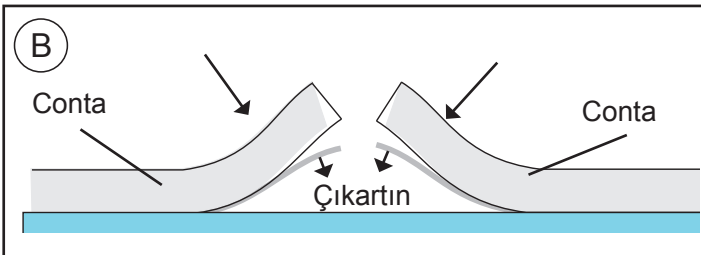
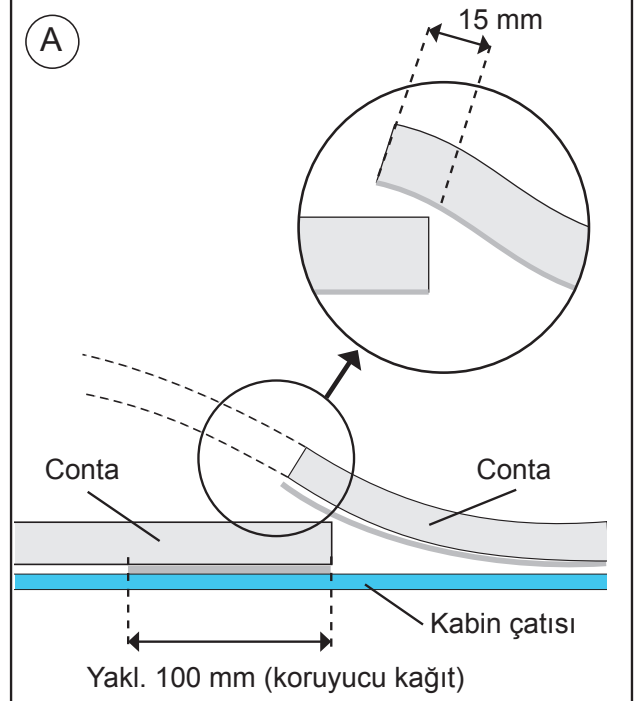

5

**DIŐ KABİN:**

Compact'ı kaporta boşluđuna konumlandırın.

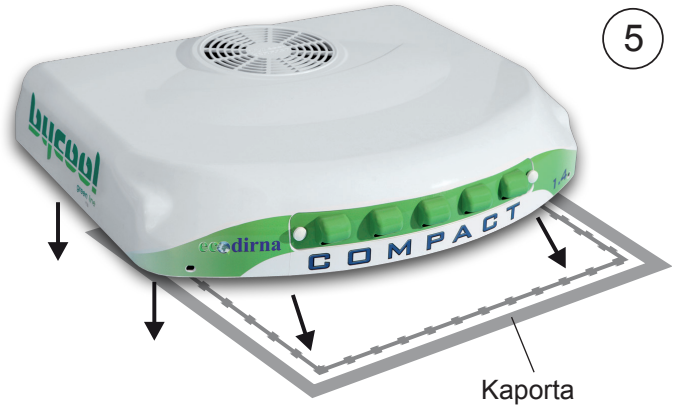

5



**Dikkat!** Ekipman ambar açılıő yerleőtirerek, drenaj çıkıőları EPDM conta tarafından bloke olmadıđını kontrol edin.

6

Köpük kanallayıcıyı cihazın altındaki en yumuőak yere yerleőtirin.



7

**İÇ KABİN:**

Yaklaőık 10 mm (4) civatayı 8/125x70, lastik pul, yassı pul, somun ile yerleőtirerek sıkın.

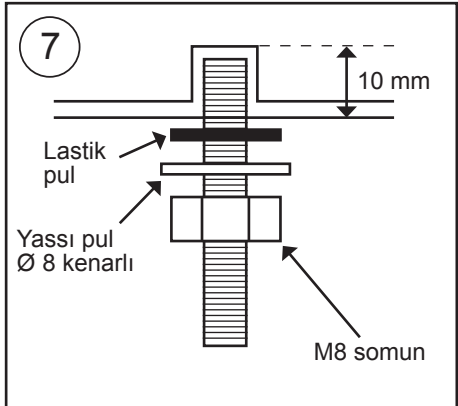
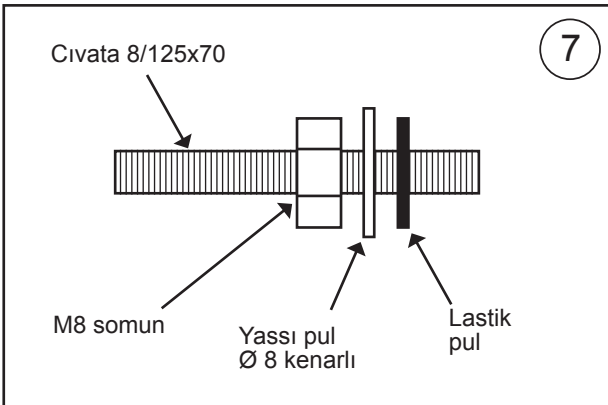

8

Sıkmaksızın montaj aparatını yerleştirerek (2) yassı pulları kilit somunu arasına yerleştirin.

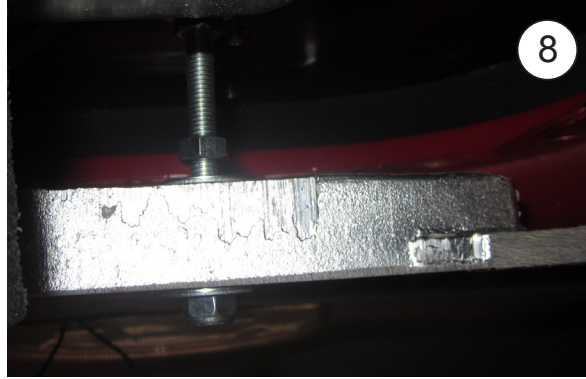
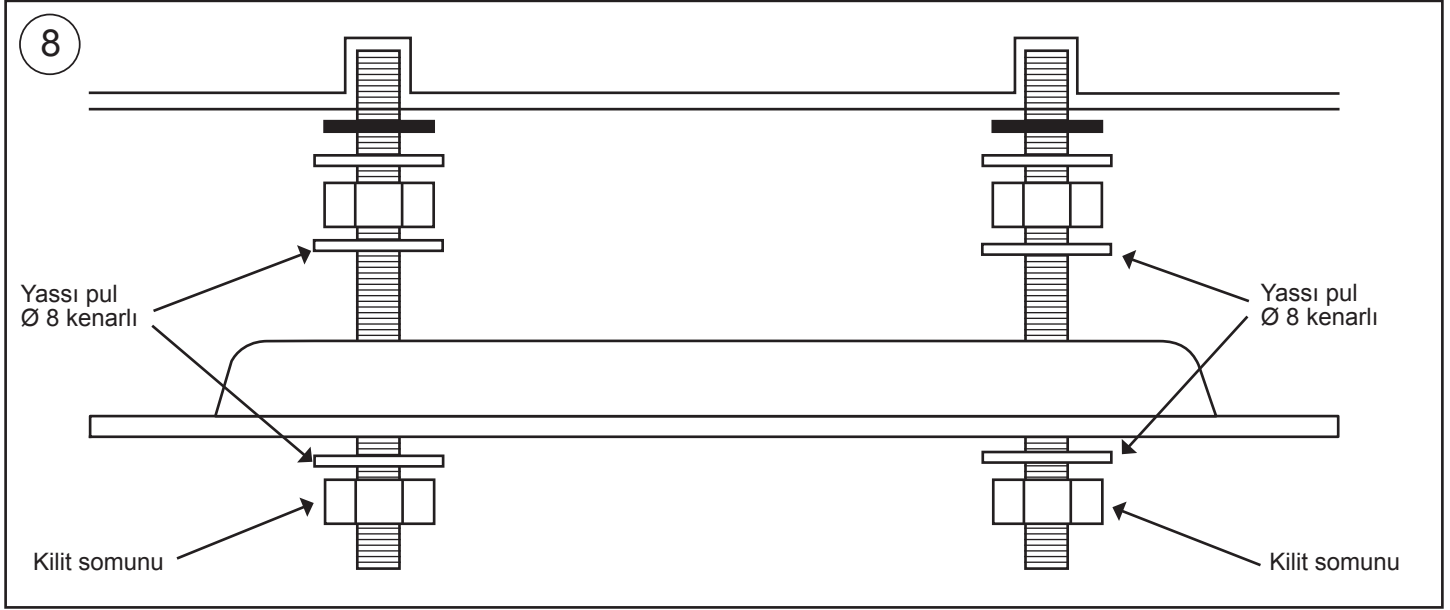

9

Yaklaşık 10 mm (4) civatayı M6 x 80, lastik pul, yassı pul, somun M6 ile yerleştirerek sıkın.

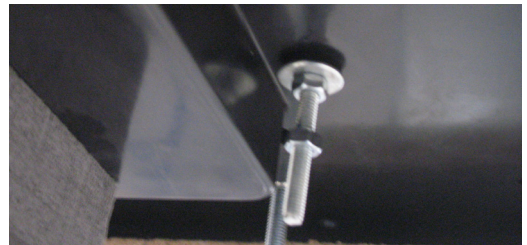
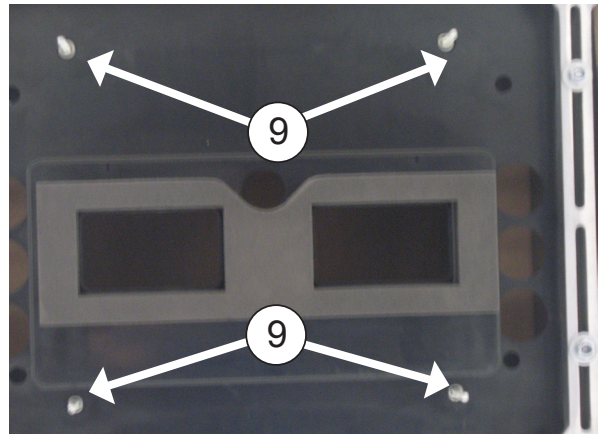
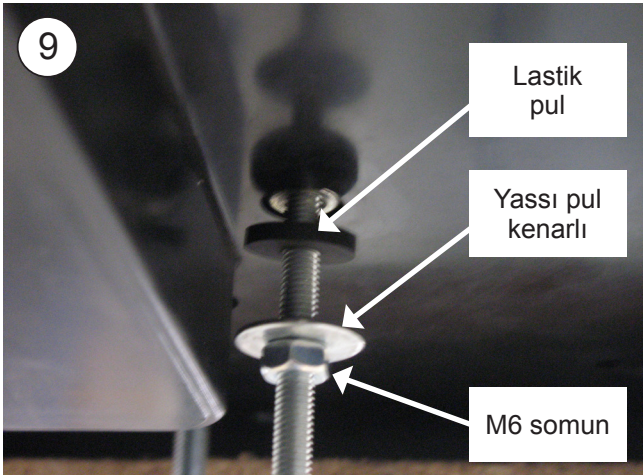

10

Herbir cıvataya **sıkmaksızın** (1) M6 somun yerleştirin.

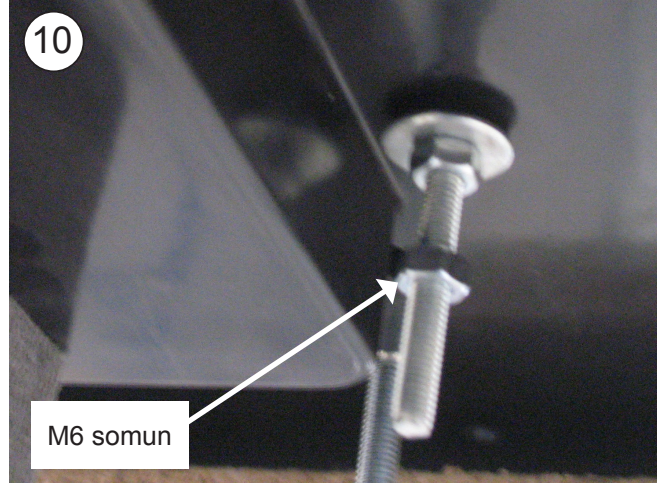

11

(2) 4 yollu kutuyu (4) 2 yol ile hava dağıtma iç panelinden **Compact** ile bağlayınız.

**Dikkat: Kondansatör vantilatörünün 2 yollu bağlantı kutusunun ters takılmaması çok önemlidir (R ve N kablolu kutu).**



12

Kanallayıcıların ayarını cihazın tabanı ile engellememesi için kabloları hava dağıtma iç panelinden mevcut deliğe (**H**) sokun.

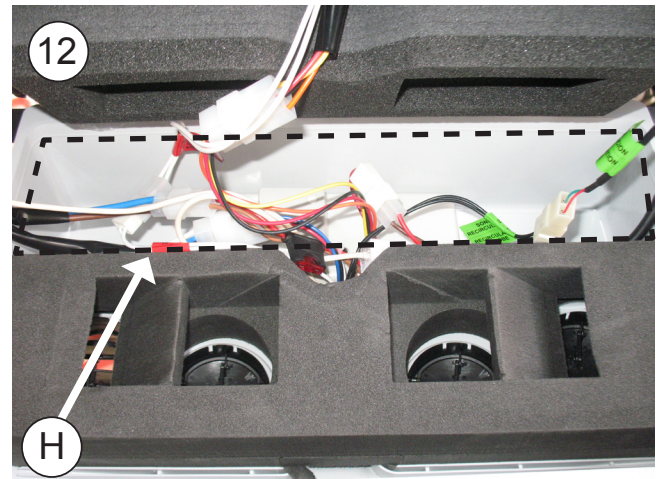

- 13** Hava dağıtım iç panelini önceki cıvataları 1 somun M6, 1 yassı pul Ø 6 kenarlı ile yerleştirin ve bir altıköşeli L=25 ile sabitleyin ve sıkın.

**Not: Altıköşeli, döşemenin 1 mm üstünde olmalıdır.**

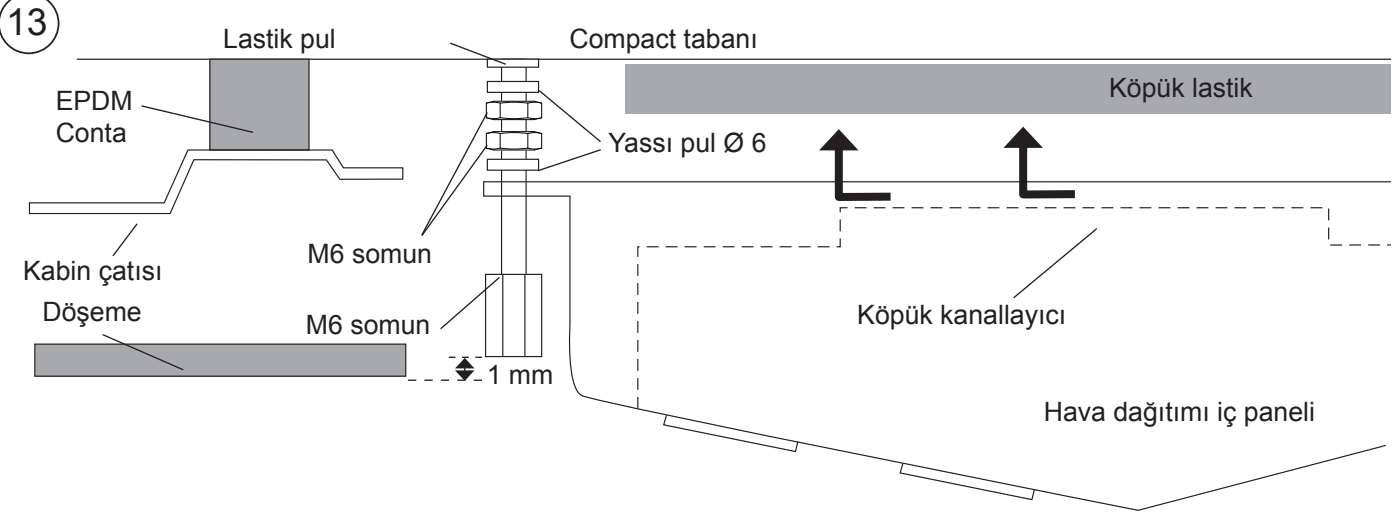

- 14** Somunu nokta 10'dan hava dağıtım iç panelinin en üst sınırına gelinceye kadar sıkın.

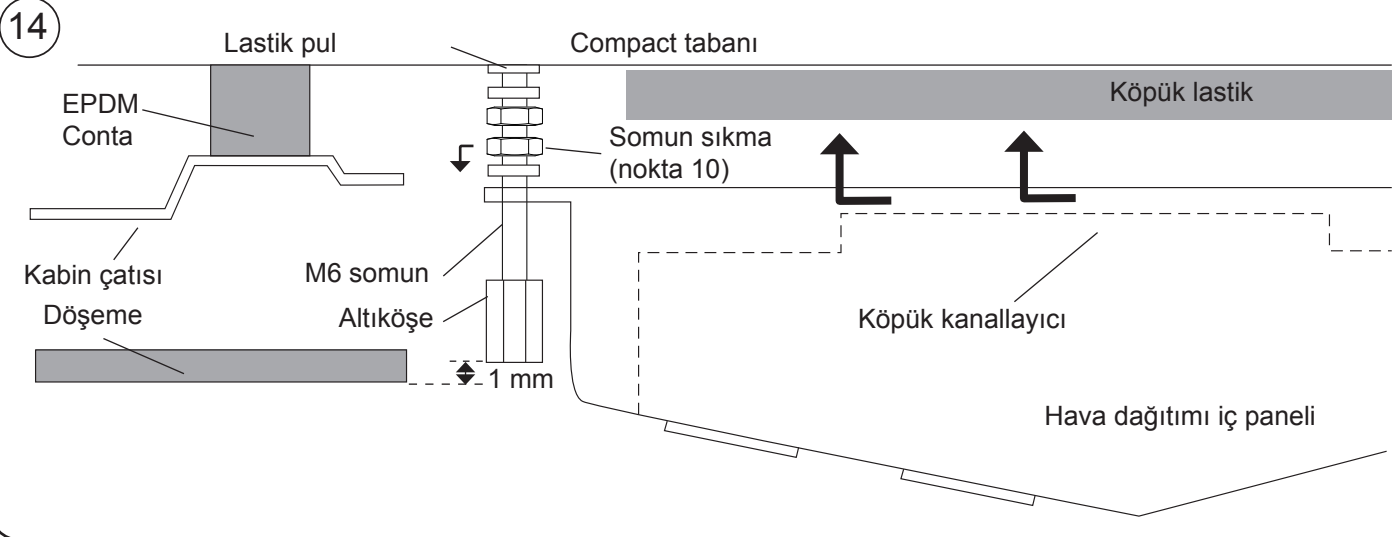

- 15** Konsolları yerleştirin ve cihazı merkezleyin. Merkezledikten sonra konsolu çikartın.



**16**

Kilit somunları çekerek üst somun sınırına gelinceye kadar destek tespitlerini sabitleyin.

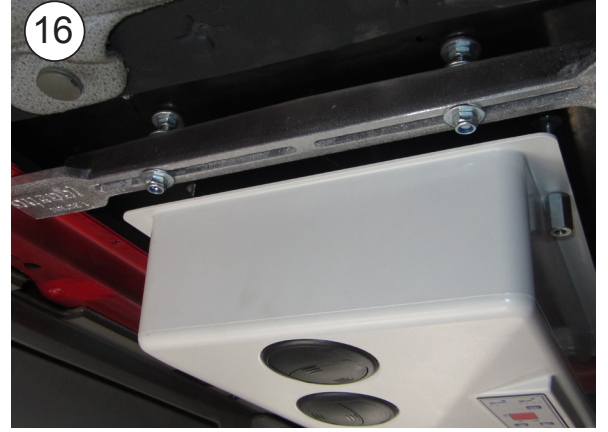
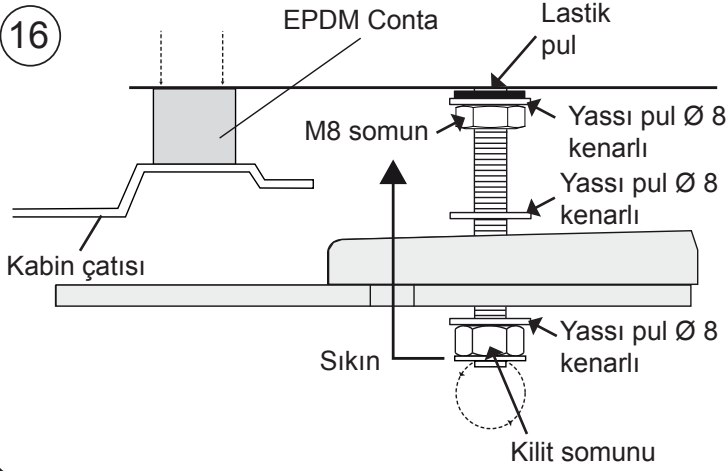
**16****17**

Yassı konsolu yerleştirin, devamında diğer konsolu yerleştirin ve (4) Allen civatası ile M6/100x15 sabitleyin.

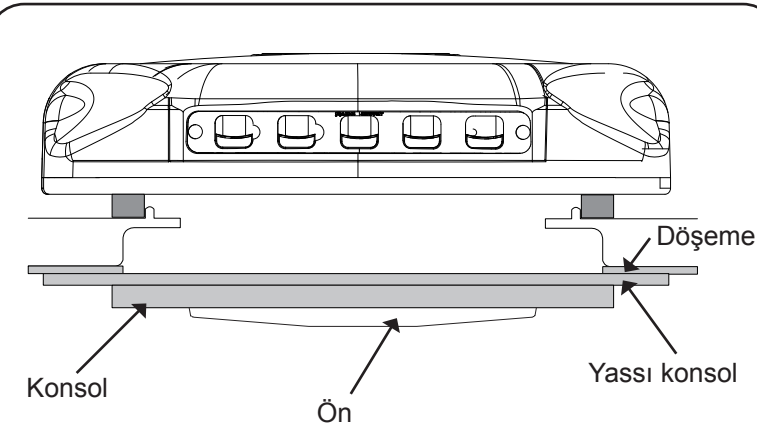
**17****18**

(4) Allen civatalarını M6/100x15 yuvarlak M6 plastik parçalar ile kapatın.

**18**

## BESLEME KABLolarININ DÖŞENMESİ HAKKINDA AYRINTILI TALİMATLAR

**1**

Cihazın kablosunu bağlayın ve kamyonun arkasından sol taraftan alın.

**2**

Kabloyu plastik destek, bant ve flanşlarla sabitleyin. Kabloyu, batarya kablosu ile birbirine bağlayın (A).

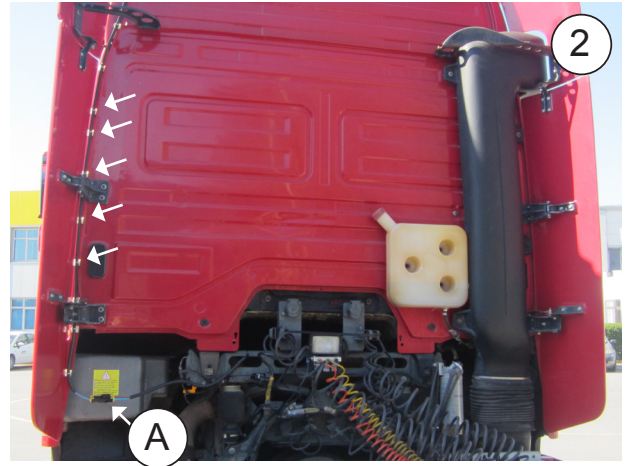
**3**

Kabini kapatın ve orijinal kabloların geçtiği şekilde işlemi alttan geçirin.





## BESLEME KABLOLARININ DÖŞENMESİ HAKKINDA AYRINTILI TALİMATLAR

4

Batarya kabloları ile orijinal kabloları biraraya getirin ve mavi kablo (+) ile kahverengi kabloyu (-) temas ettirin.

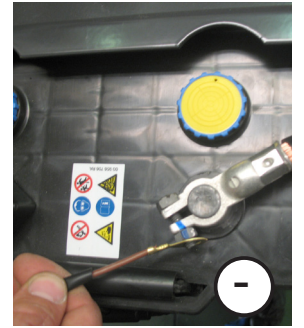
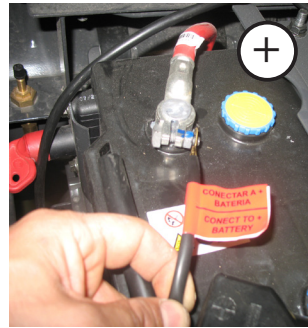

**KABİNİN HAREKETLERİ NEDENİYLE OLUŞABİLECEK KIRILMALARI ÖNLEMELİK İÇİN KABLULARI BAĞLARKEN, UYGUN UZAKLIK PAYI BIRAKIN.**

**ÖNEMLİ:** Cihazın kompleks bir elektronik düzenleme sistemine sahip olması nedeniyle, güç alımı doğrudan aracın bataryasından yapılmalıdır.

**ÖNEMLİ:** İşletime almak için Kullanım Kılavuzuna bakınız.

## Elektrik şeması

## ÖNEMLİ BİLGİ!

Cihazı, batarya ile bağlarken kutup uçlarını değiştirmemeye **dikkat edin**. Bunun olması durumunda pano açılmaz ve cihaz çalışmaz.

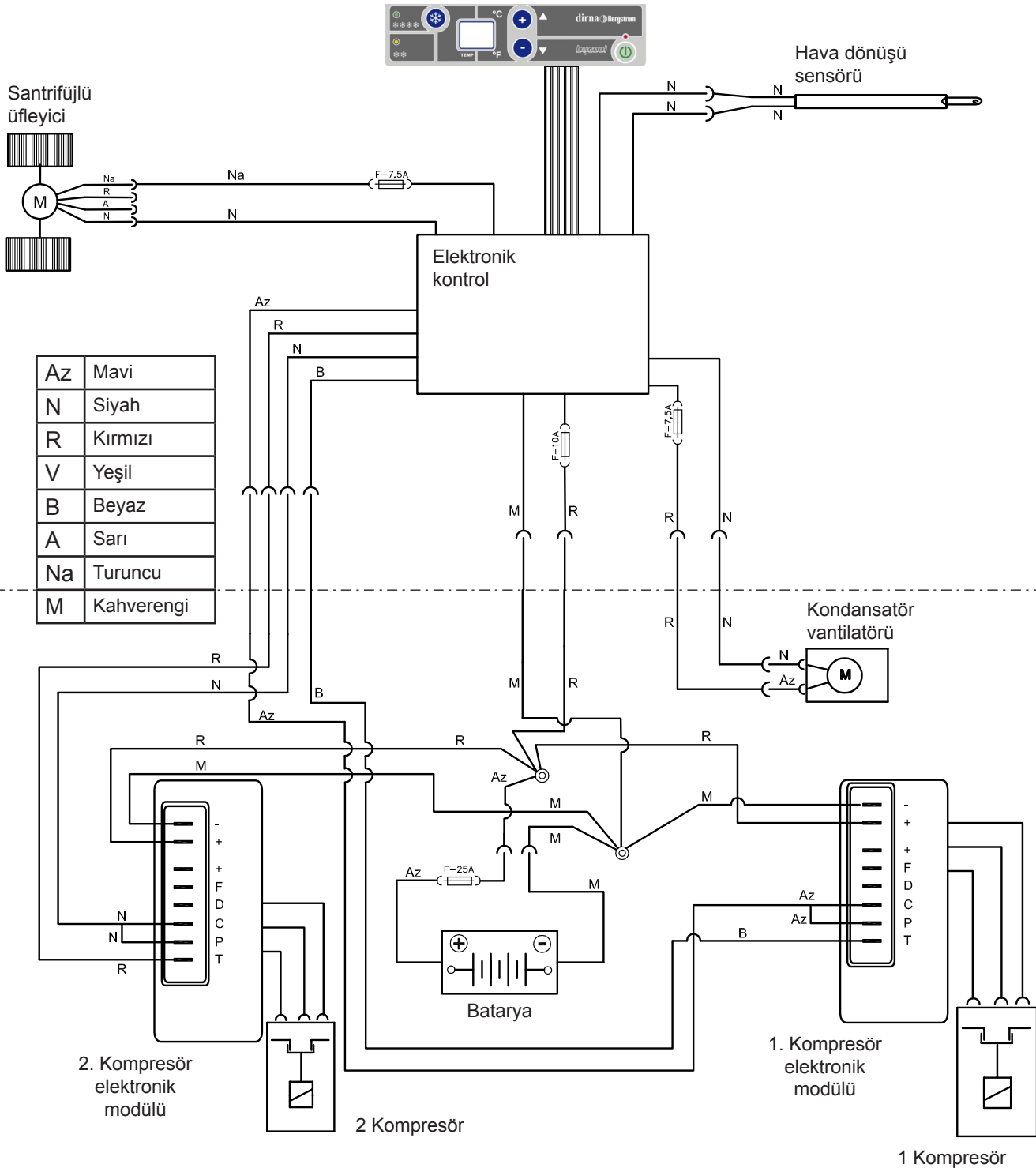

## Range of Products

**BYCOOL!**  
 green line

**Air conditioning**



**COMPACT 1.4**



**COMPACT 1.6**



**COMPACT 2.0**



**COMPACT 3.0**



**BYCOOL!**  
 blue line

**Evaporative Cooler**



**FLAT**



**REVOLUTION**



**CAMPER**



**MOCHILA**

Dirna Bergstrom es titular de todos los derechos de la presente información. La presente información es confidencial y queda prohibido cualquier acto de reproducción, distribución, comunicación pública y/o transformación de cualquier elemento de la misma sin la previa y expresa autorización de Dirna Bergstrom. Esta información ha de ser utilizada única y exclusivamente para el fin para el que fue creada, no siendo Dirna Bergstrom responsable de los posibles daños que se pudiera causar al cliente y/o a terceras partes por un incorrecto y/o inadecuado uso de la misma. Para cualquier aclaración al respecto pueden dirigirse al Centro de Comunicaciones del fabricante Dirna Bergstrom.

*DIRNA BERGSTROM is the holder of all the rights of this information. This information is confidential and it is absolutely forbidden any act of reproduction, distribution, public communication and/or transformation of any element of it without the previous and express authorization of DIRNA BERGSTROM. This information must be used only and exclusively for what it has been created, DIRNA BERGSTROM doesn't assume any responsibility of possible damages that could be caused to the client and/or third parties for a wrong and/or inadequate use of it. For any doubt about the aforementioned please contact DIRNA BERGSTROM by Communication Centre.*

Ed:	22/04/2014
Md:	04/08/2015

d



Francisco Alonso, 6  
28806 Alcalá de Henares, Madrid  
SPAIN

Contact	Phone	Fax	E-Mail
Sales (Ventas Internacional)	+34 91 8770510	+34 91 8771158	sales@dirna.bergstrominc.com
Comercial Nacional	+34 91 8775841	+34 91 8836321	ventas@dirna.bergstrominc.com
Orders & Deliveries (Logística internacional)	+34 91 8775846	+34 91 8771158	export@dirna.bergstrominc.com
Orders & Deliveries (Logística nacional)	+34 91 8775840	+34 91 8836321	comercial@dirna.bergstrominc.com
Technical Assistance (Internacional)	+49 511 86679681	+49 511 86679710	technicalassistance@dirna.bergstrominc.com
Technical Assistance (Nacional)	+34 91 8775845	+34 91 883 6321	jcastillo@dirna.bergstrominc.com

[www.dirna.com](http://www.dirna.com)  
[www.bycool.com](http://www.bycool.com)

	<b>ATENCIÓN:</b>	Dirna Bergstrom se reserva el derecho de efectuar modificaciones en cualquier momento de los datos contenidos en esta publicación, por razones técnicas o comerciales.
	<b>NOTE:</b>	<i>For technical and commercial reasons, Dirna Bergstrom reserves the right to change the data contained in this brochure.</i>
	<b>ATTENTION:</b>	Dirna Bergstrom se réserve le droit d'effectuer à tout moment des modifications des données reprises sur cette publication, pour des raisons techniques ou commerciales.
	<b>HIWEIS:</b>	<i>Dirna Bergstrom behält sich vor, aus technischen oder kaufmännischen Gründen jederzeit Änderungen der Angaben dieser Veröffentlichung vorzunehmen.</i>
	<b>ATTENZIONE:</b>	Dirna Bergstrom si riserva il diritto di effettuare modifiche in qualsiasi momento ai dati contenuti in questa pubblicazione, per motivi tecnici o commerciali.