

CE

 Bergstrom®

# INTEGRAL // POWER //



**Instrucciones de Montaje**

*Mounting Instructions*

**Instructions de Montage**

*Montageanweisungen*

**Istruzioni di Montaggio**

**ES** Spanish

**EN** English

**FR** French

**GE** German

**IT** Italian

F-4218 rev.01



1002597509

### Recomendaciones Para el montaje

- Antes de iniciar el montaje leer las instrucciones y seguirlas durante el proceso de instalación.
- Usar las herramientas adecuadas para cada operación.

### Electricidad

- Desconectar la llave de contacto.
- Desconectar la batería antes de empezar el montaje.
- Asegurar el conexionado de los componentes eléctricos, verificando su correcto encaje.

### Atención

Si durante el montaje el equipo se inclina o se abate la cabina con el equipo montado, se deberá esperar un mínimo de 60 minutos, desde que el equipo quede horizontal, antes de ponerlo en marcha.

### Atención

Al instalar el equipo de aire acondicionado en el techo se debe proteger la parte superior de la cabina con un paño ó manta protectora para evitar posibles arañazos. Al instalar **Integral Power II** en el techo hay que tener en cuenta que, normalmente, las cabinas que vienen provistas de escotilla, tienen una estructura suficiente para soportar el peso del equipo. Sin embargo, cuando no ocurra así y sea necesario realizar corte en el techo ó incluso si en el caso de llevar escotilla el material no es lo suficientemente resistente (caso de techo de fibra, plástico, etc...) es el instalador el que debe decidir, **bajo su responsabilidad**, sobre la necesidad de reforzar el techo para evitar posibles deformaciones, roturas, entradas de agua, etc... habilitando los medios para que esto no ocurra.

**En las cabinas de fibra se debe tener especial cuidado y únicamente apoyarse en los nervios de la misma para evitar hundimientos en la parte de fibra.**

### Herramientas

Juego de Llaves Torx

Juego de Llaves Allen

Llave fija 13

Tijeras

Flexómetro

### Documentación relacionada

Instrucciones de montaje 1002597509

Manual del usuario 1002192411

Diagnos de averías 1002192414

Listado de recambios 1002597510

### Documentación incluida

Guía rápida 1002455105

Garantía 220AA10017

### Simbología



Frágil



Atención corte!



Riesgo eléctrico

### Advertencias



El personal instalador debe poseer una formación suficiente en Aire Acondicionado de vehículos.



**Bergstrom** queda exenta de responsabilidad si se producen averías que procedan de una inadecuada manipulación o instalación del equipo, o por modificaciones y sustituciones efectuadas sin nuestra expresa autorización por escrito.



**Equipo precargado con gas refrigerante. (No manipular el circuito de gas refrigerante).**



Véase **procedimiento de garantía** del producto incluido en **Diagnos de Averías**.



Véase **Manual de Usuario** del equipo para el correcto funcionamiento del mando a distancia y del panel de control.



Al finalizar la instalación se debe entregar al usuario: **Manual del Usuario, Garantía y Diagnos de averías.**



**Atención:** peso del equipo 52 Kgs.

**⚠ Atención**

Cualquier modificación de los sistemas ROPS / FOPS, como soldar o perforar agujeros en partes estructurales, afectará la capacidad de ROPS / FOPS para proporcionar la protección requerida. La instalación de este producto puede afectar los sistemas ROPS / FOPS.

Póngase en contacto con su distribuidor autorizado para verificar la compatibilidad antes de realizar modificaciones o reparaciones. De lo contrario, puede anular la certificación ROPS / FOPS. El fabricante del aire acondicionado de techo no asume responsabilidad alguna.

**1** Desmontar tapa escotilla, los elementos de fijación y entregar éstos al cliente (\*).

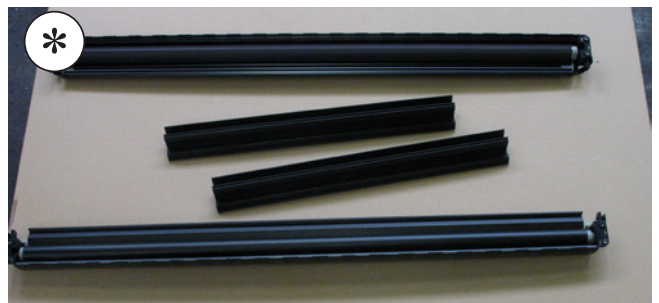

**2** Quitar los residuos sobrantes adheridas al techo antes de pegar la junta EPDM.

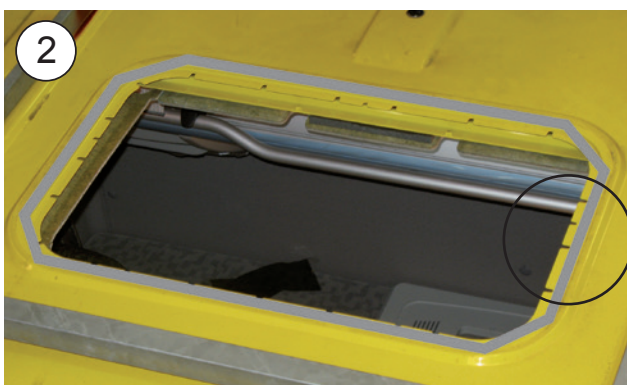

3

Pegue la junta EPDM alrededor del hueco de escotilla (mirar el detalle para cortar los bordes finales de unión de la junta).

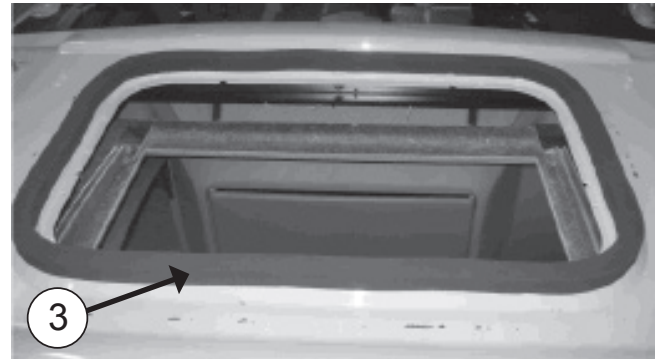

**COMO CORTAR LA JUNTA EPDM PARA EVITAR FILTRACIÓN DE AGUA EN LA CABINA**

- A- Pegar la junta, manteniendo 100 mm de papel protector por cada lado.
- B- Quita los dos piezas de papel.
- C- Pegue presionado ambos finales.

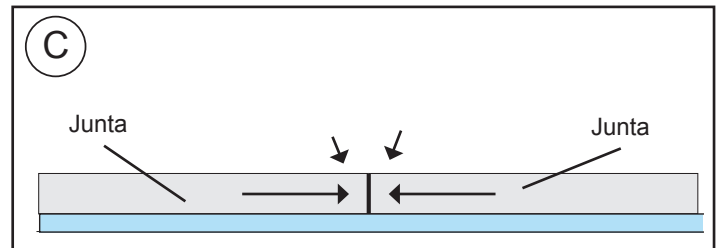
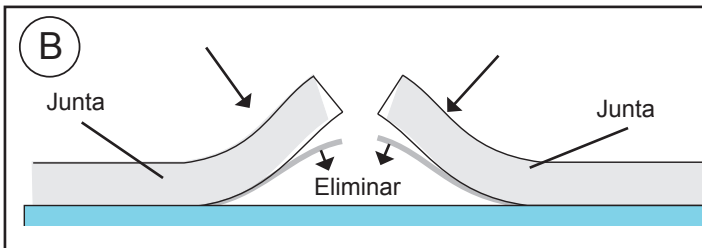
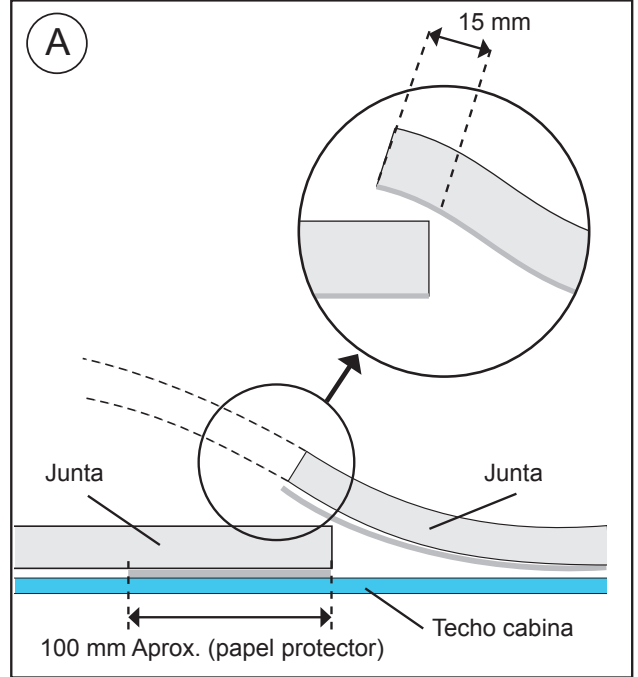

**Importante:** El equipo Integral Power II está dotado con 4 cartelas soldadas en los laterales de su base para facilitar su alzado seguro mediante un equipo mecánico de elevación.

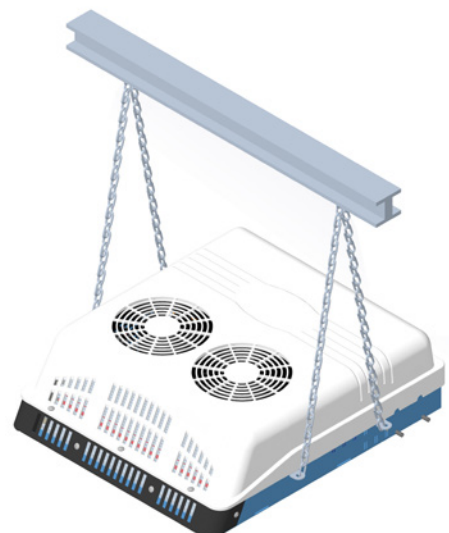
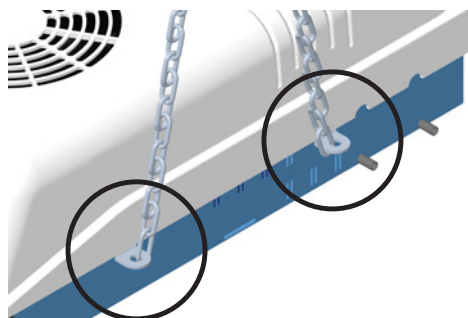



**4** **EXTERIOR CABINA:**  
 Posicionar el equipo **Integral Power II** en el hueco de la escotilla.

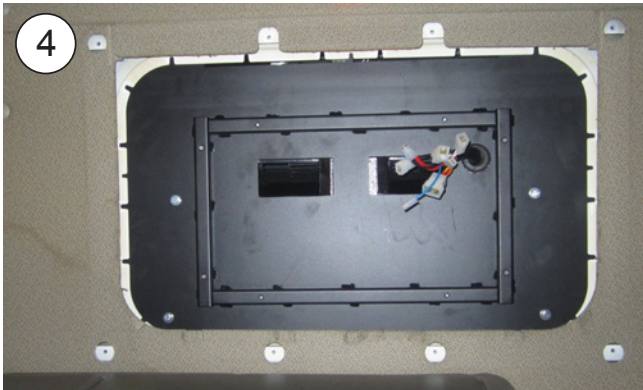

**5** **INTERIOR CABINA:**  
 Roscar 5 mm aproximadamente (4) espárragos 8/125x100-70 o 120 en las roscas de los refuerzos indicados (\*), la medida se elegirá tras presentar los soportes de sujeción y teniendo en cuenta que los espárragos deben sobresalir de los mismos por la parte inferior unos 20 mm.

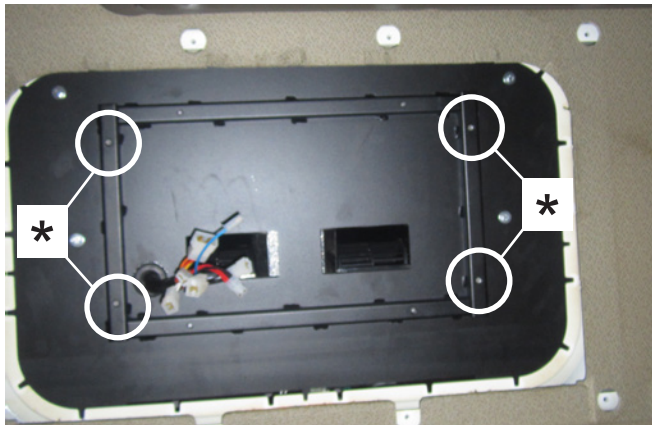
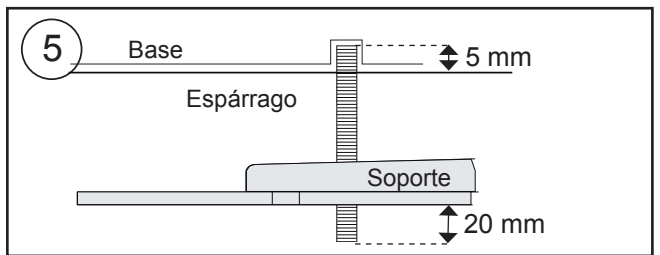

**6** Colocar (1) arandela Ø 7 de goma, (1) arandela plana Ø 8 ala ancha, (2) tuerca M8 y (1) arandela plana Ø 8 ala ancha, en cada uno de los espárragos anteriores; siguiendo dicho orden.

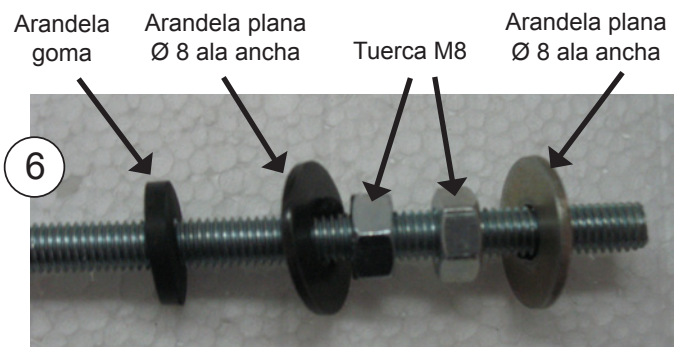

**7** Colocar (2) soportes sujeción, con (4) arandela y (4) tuerca autoblocante M8, **sin llegar a apretar**.

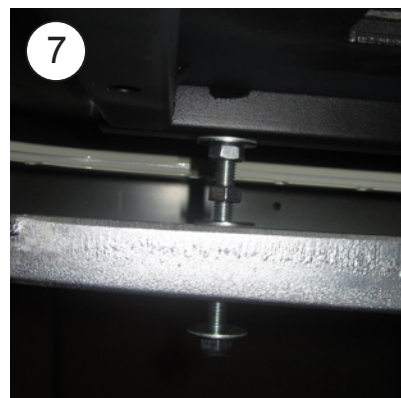
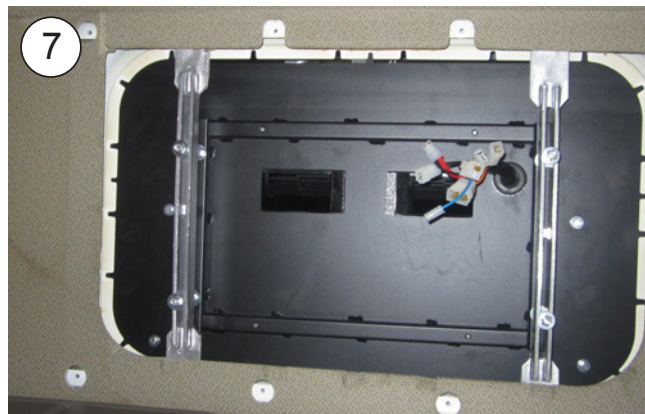

**8** Roscar 10 mm (4) espárragos M6 x 55 o 80, donde se indica, según distancia (D) del esquema del punto 11.

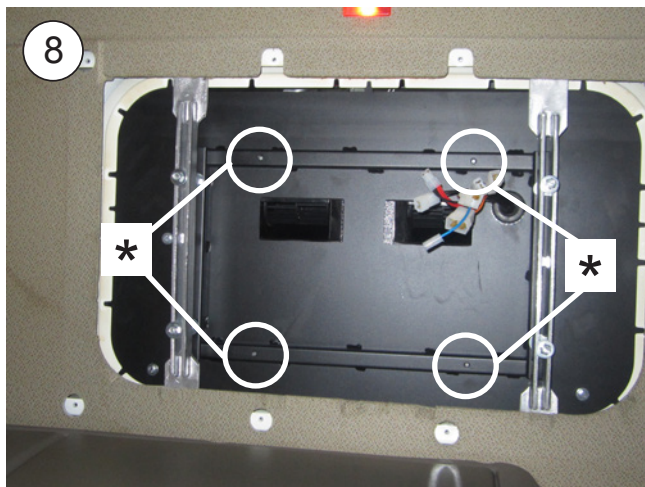

**9** Colocar (1) arandela Ø6 de goma, (1) arandela plana Ø6 ala ancha y (1) tuerca M6, sobre cada uno de los espárragos de M6. **Apretar tuerca**, a continuación apretar tuerca hasta que la arandela de goma quede un poco oprimida.

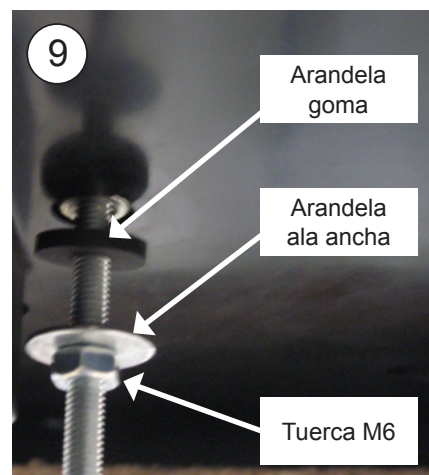

**10** Conectar cableados del equipo con los del panel interior de distribución de aire haciendo coincidir cajas y colores.

**11** Colocar panel interior de distribución de aire en los espárragos anteriores con (1) arandela M6 ala ancha y (1) tuerca M6 en cada espárrago. Apretar tuercas hasta que los canalizadores hagan tope en goma espuma superior.

**Importante:** Los canalizadores deben hacer tope contra la goma espuma superior para evitar fugas de aire.

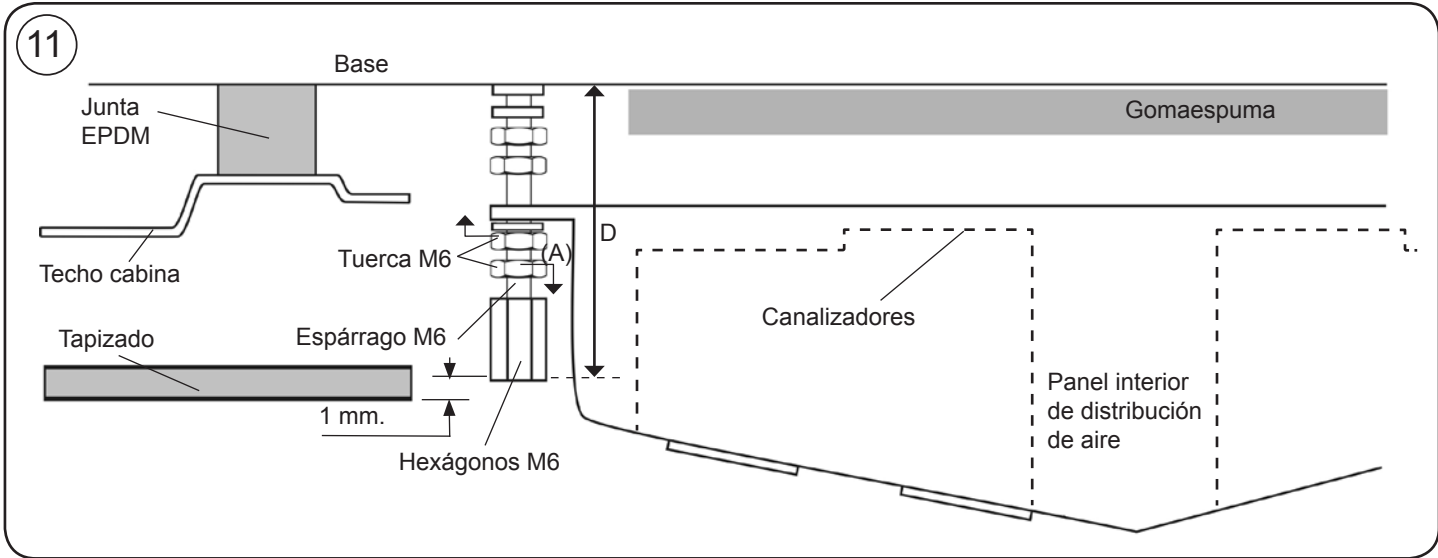

**12** Presentar consola y centrar el equipo. Una vez centrado quitar consola.





13

Fijar los soportes de sujeción apretando las tuercas hasta el apriete de la junta de EPDM exterior (Punto 4) del equipo entre 3 y 6mm; la junta debe quedar con un espesor entre 19 y 22 mm.

**Importante:** Para evitar posibles filtraciones de agua al interior de la cabina se debe asegurar el apriete de la junta EPDM con la base del equipo tal y como se indica en el esquema.

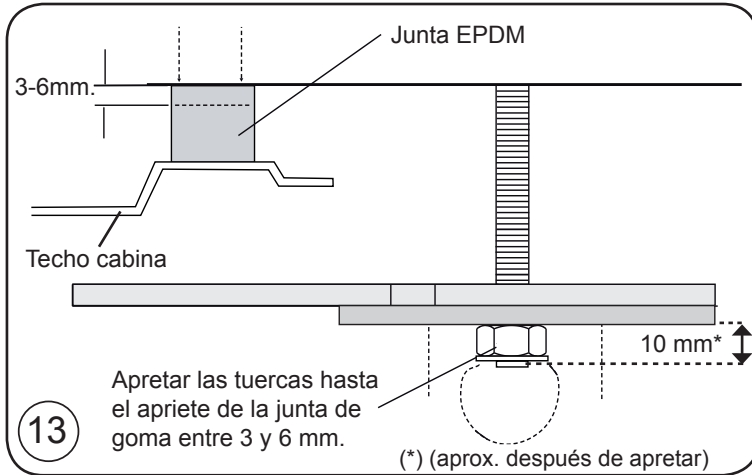
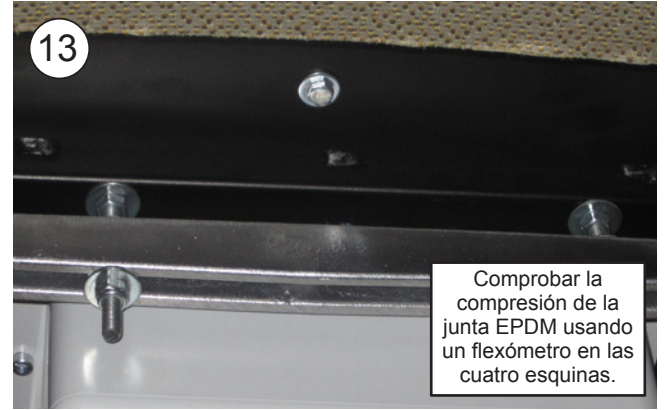

14

Apretar (4) tuercas M8 al soporte y (4) a la base del equipo.

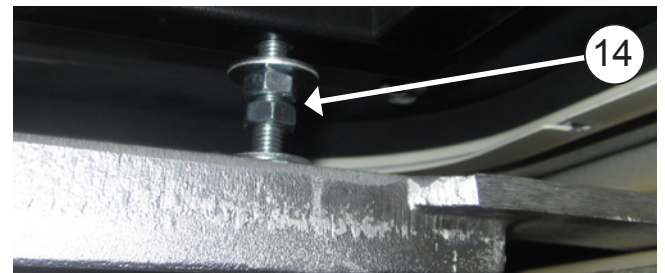



**15** Conectar sensor aire de retorno a la clema situada en el hueco de entrada de aire.

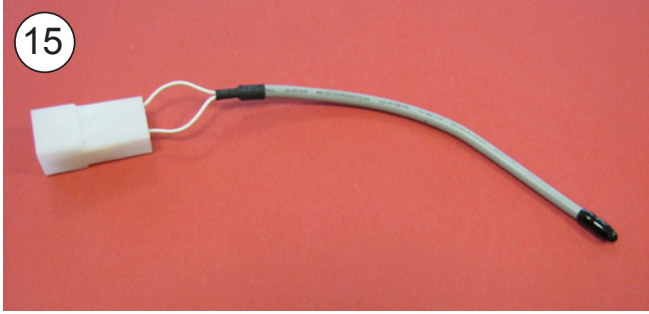

**16** Colocar tuerca M6 (A) tras la tuerca de fijación del panel interior de distribución de aire en cada espárrago. Colocar hexágonos M6 roscándolo hasta que quede 1 mm por encima del tapizado. Desenroscar tuercas M6 (A) de este punto hasta que haga tope con los hexágonos y apretar contra estos.

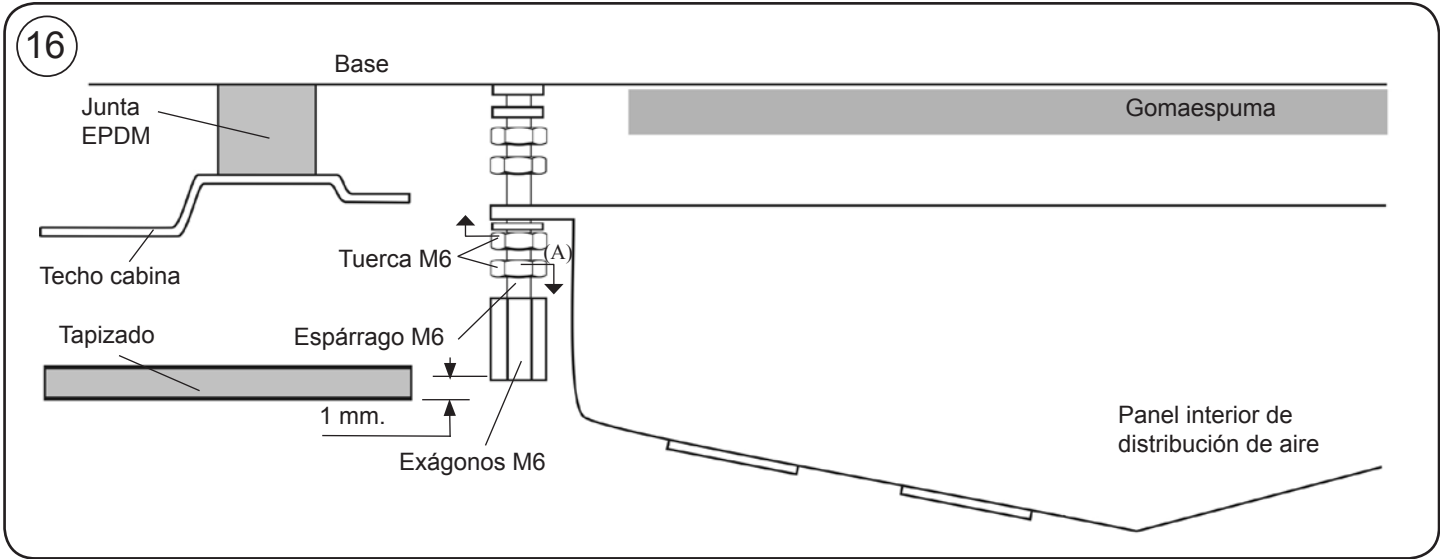
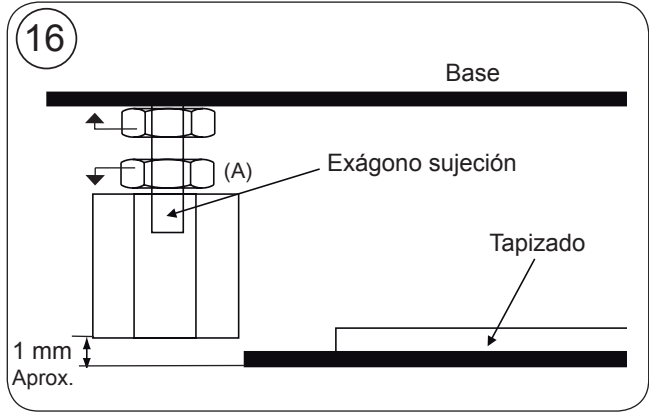

**17** Colocar la consola con (4) tornillos M6/100x15 allen.

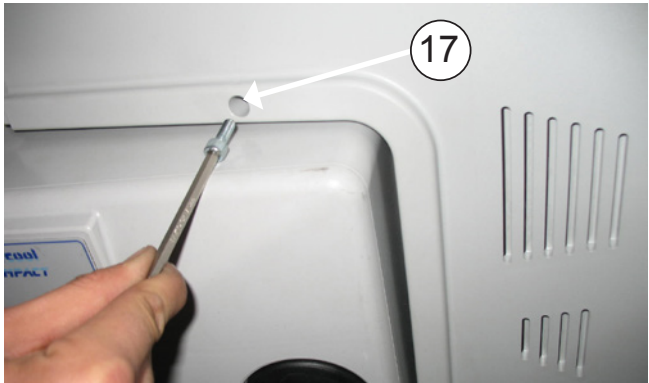

**18** **Atención:** La sonda de recirculación deberá quedar como se indica para que capte la temperatura del interior de la cabina.



**19** Cubrir los (4) tornillos M6/100x15 allen con los embellecedores redondos de plástico.



## TUBOS DE DESAGÜE

**1** Montar (4) válvulas en tubos de desagüe.



**2** Sujetar con (4) abrazaderas y (4) tornillos como se indica.



**3** Comprobar que no interfieren con el techo de la cabina, para evitar que se obstruyan.



**Instrucciones detalladas sobre la instalación del cableado de alimentación**

**4** Conectar el cable de alimentación superior en la parte trasera del equipo y llevarlo por la parte posterior de la cabina pegando los soportes de plástico y fijándolo con bridas.

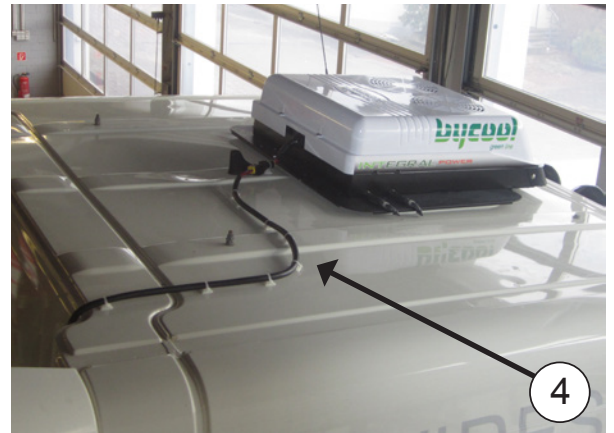
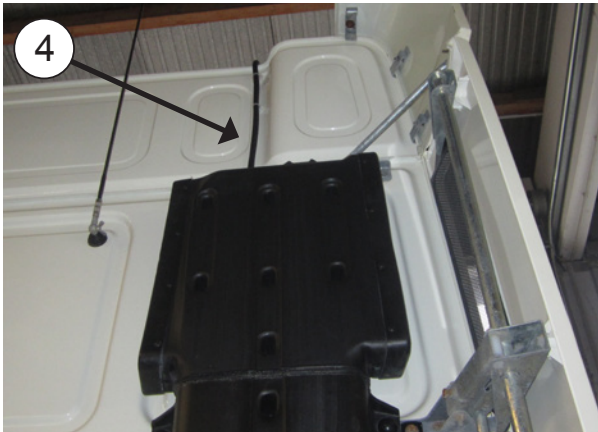

**5** Conectar cable de alimentación inferior en batería, llevándolo por el paso de cableados original, sujeto con bridas, hacia la parte posterior de la cabina, para conectar con el cable de alimentación superior.



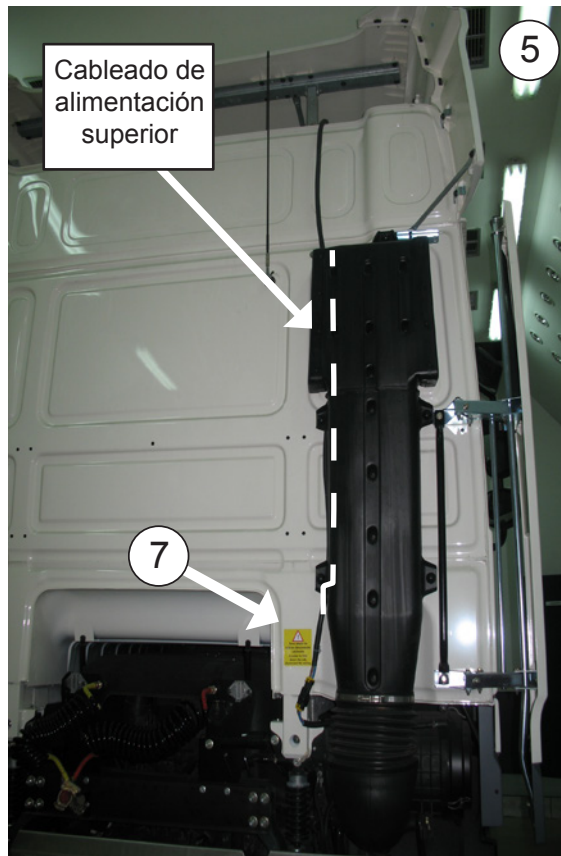

 **Importante:** al conectar los cableados ,dejar la distancia adecuada ,para evitar su rotura por los movimientos de la cabina.

**6** **Importante:** Debido al complejo sistema de regulación electrónica del equipo, la toma de corriente debe realizarse directamente a la batería del vehículo.

**Importante:** Para la puesta en marcha consultar el Manual del Usuario.

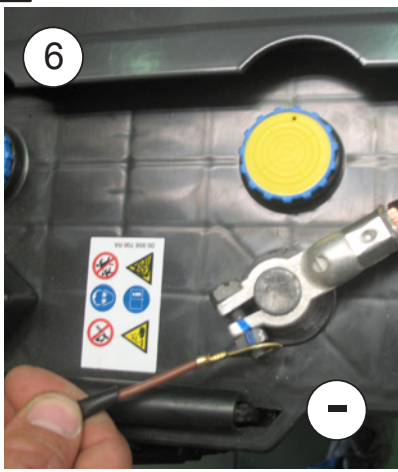
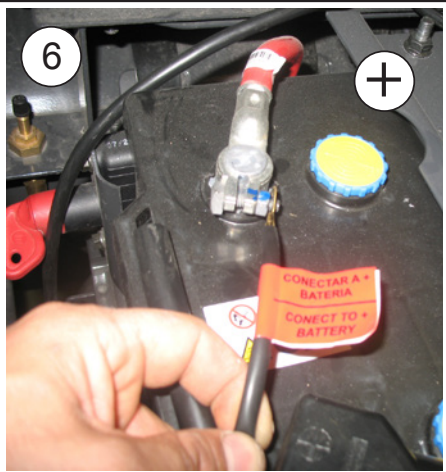

**7** Colocar adhesivos de peligro en unión de cableado y en dispositivo de elevación de cabina.



**Cableado de conexión a alternador o bajo llave de contacto para funcionamiento del equipo con motor en marcha**

 **Atención:** El cableado se instalará en todos los vehículos para que el equipo funcione a motor arrancado.

**8** Colocar cableado de excitación por el interior o por el exterior del vehículo según convenga y montar frente con tornillos roscachapa suministrados. Conectar interruptores como se indica.

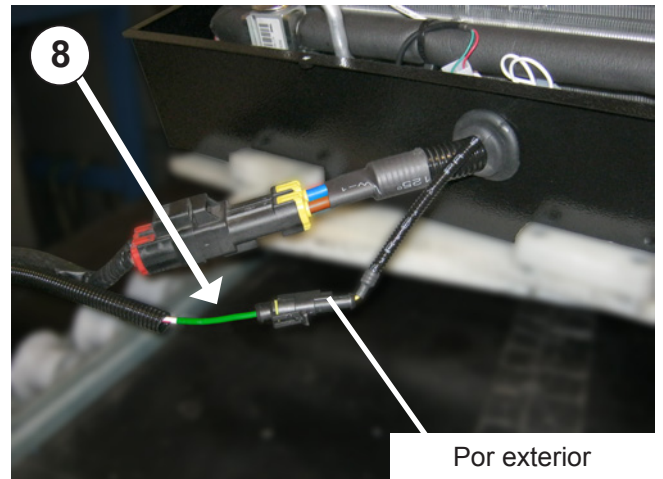

Interruptor velocidades aire

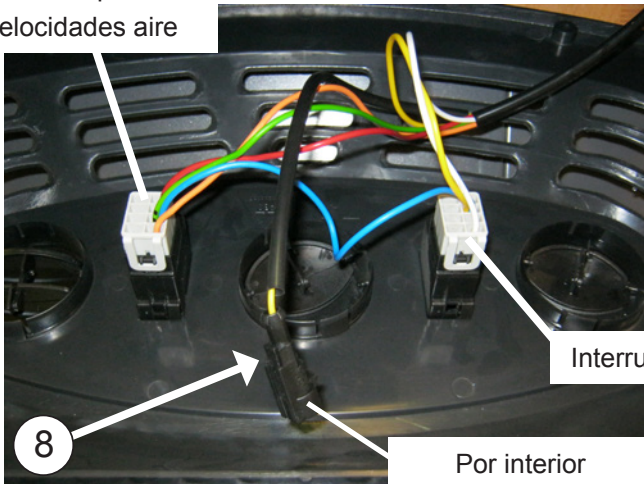



**9**

Conectar el otro extremo del cableado suministrado en posición (+) sólo con motor arrancado o a través de (+) llave de contacto.

**10**

Conectar cable de alimentación superior en la parte trasera del equipo.

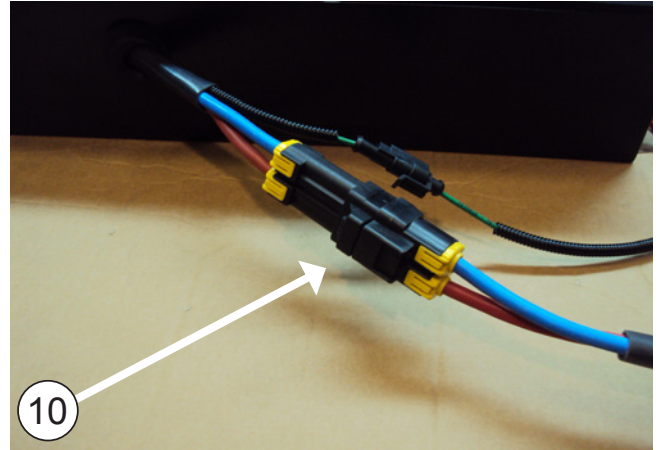

Esquema eléctrico

Az	Azul
N	Negro
R	Rojo
V	Verde
B	Blanco
A	Amarillo
Na	Naranja
M	Marrón

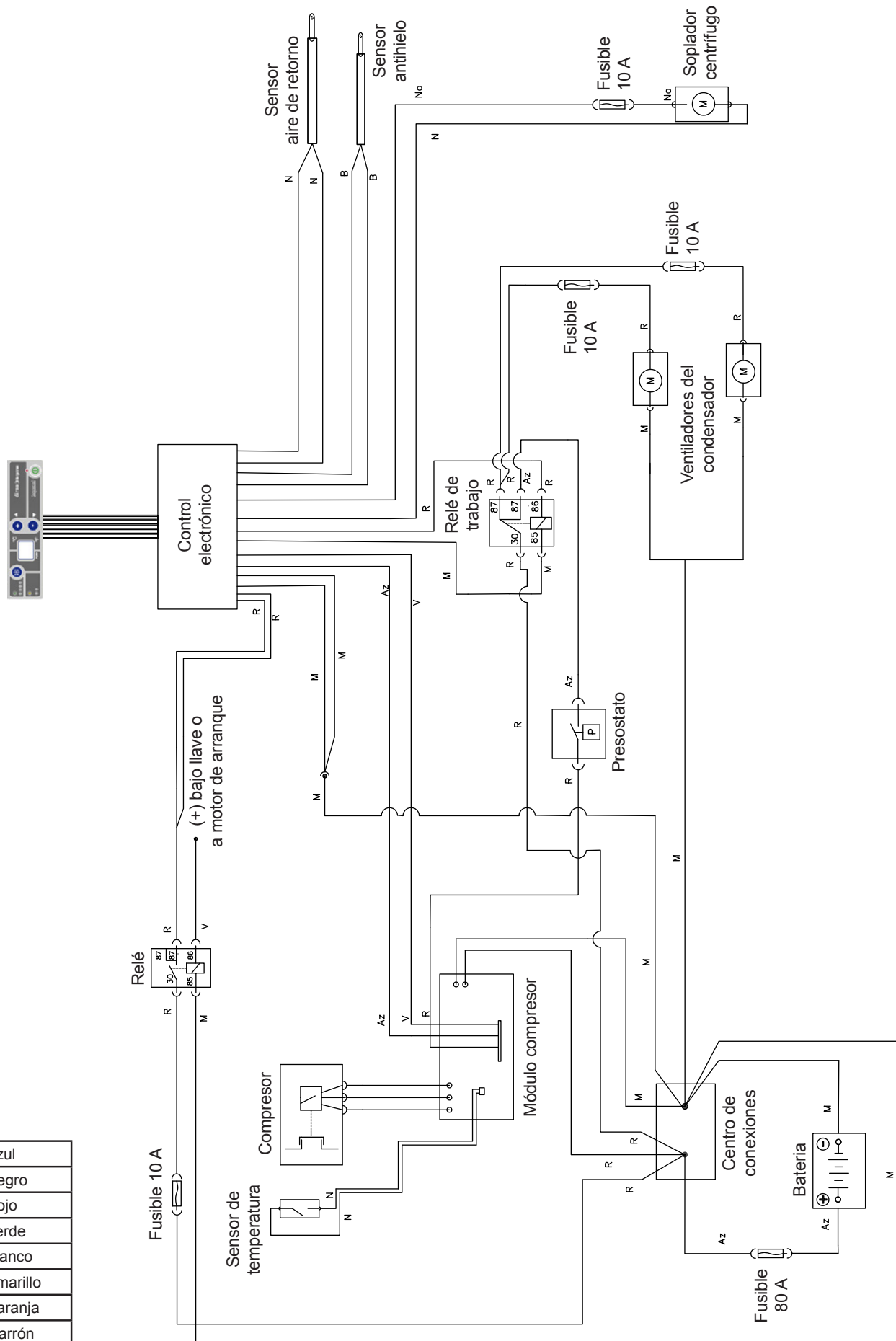

A series of horizontal dotted lines spanning the width of the page, providing a template for writing or drawing.



### Assembly Recommendations

- Before starting assembly, please read instructions and follow them during installation process.
- Use the adequate tools for each operation.

### Electricity

- Disconnect ignition key.
- Disconnect battery before starting assembly.
- Make sure electric components are securely connected, checking their correct fitting.

### Warning

If the unit slants during assembly, wait for at least 60 minutes with the unit in horizontal position before starting it up.

### Warning

When installing air conditioning equipment on roof, the upper cabin part must be protected with a cloth or a protective blanket to avoid possible scratches. When installing **Integral Power II** on roof, take into account that, normally, cabins equipped with a hatch have a strong enough structure to hold equipment weight. However, if it is not the case and it is necessary to carry out a cut in the roof or, although it has a hatch, the material is not resistant enough (*if roof is made of fibre, plastic, etc...*), it is the installer who will have to decide, under his responsibility, if it is necessary to reinforce the roof to avoid possible deformations, breaks, water entries, etc., habilitating the means required to stop it from occurring.

**With plastic roof cabins, take special care and only rest on cabin nerves to avoid fibre part from sinking.**

### Tools

- Torx wrenches set
- Allen wrenches set
- Open-jawed spanner 13
- Scissors
- Flexo-meter



### Related documentation

Mounting instructions	1002597509
User's guide	1002192411
Troubleshooting	1002192414
Parts list	1002597510







### Documentation included

Quick guide	1002455105
Warranty	220AA10017

### Symbology

-  Fragile
-  Beware of cuts!
-  Electrical hazard

### Warnings

-  The installing personnel must have a sufficient training in vehicles air conditioning.
-  **Bergstrom** shall not be responsible for breakdowns or damages coming from an inadequate handling or installation of the equipment or from modifications and substitutions carried out without our express and written authorisation.
-  **Equipment pre-charged with refrigerating gas. (Do not handle refrigerating gas circuit).**
-  **Please see product warranty procedure included in Troubleshooting.**
-  Please see equipment User's Guide for its correct functioning of the remote control and control panel.
-  Once installation is finished, the following documents must be handed over to the user: User's Guide, Warranty and Troubleshooting.
-  **Attention!** Weight of the unit 52 kg.

 **Warning**

Any modification to ROPS/FOPS, such as welding or drilling holes in the structural members for mounting brackets, will affect the ROPS/FOPS capability to provide the required protection. Installing this product may affect ROPS/FOPS systems.

Contact your authorized dealer to check compatibility before making any modifications or repairs. Failure to do so may void the ROPS/FOPS certification. The manufacturer of the roof air conditioner assumes no liability whatsoever.

**1** Take down the hatch cover and the attachment elements, and hand them over to the customer (\*).

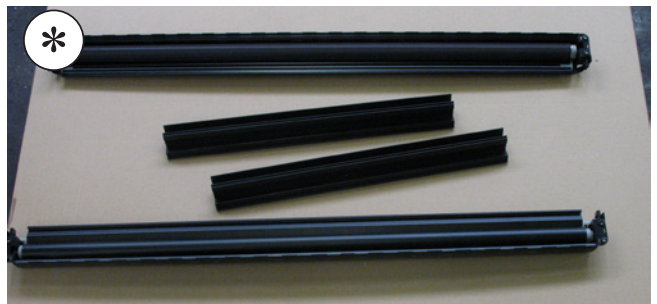

**2** Remove any excess from the roof before attaching the EPDM seal.

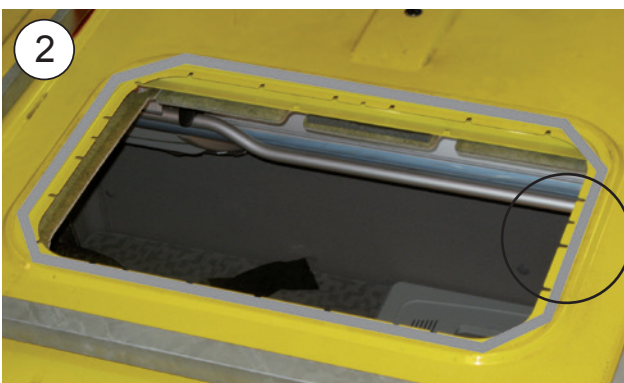

**3** Attach the EPDM seal around the hatch gap (see the details to cut the ends of the seal joint).

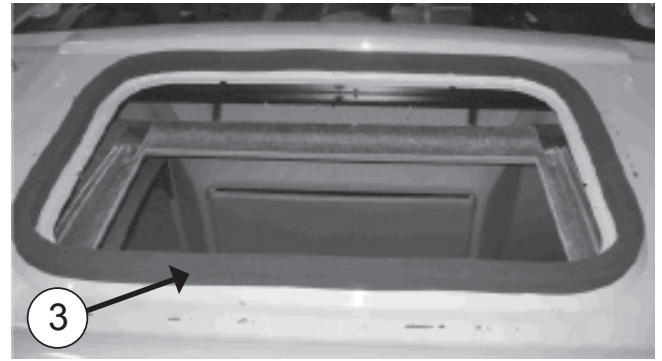

**HOW TO CUT THE EPDM SEAL TO PREVENT WATER FROM DRIPPING IN THE CABIN**

- A- Attach the seal, keeping 100 mm of protection paper on each side.
- B- Remove the two pieces of paper.
- C- Attach by pressing both ends.

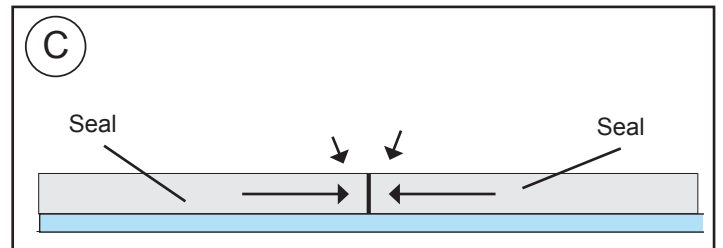
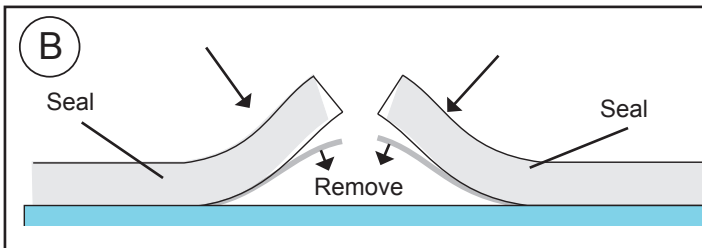
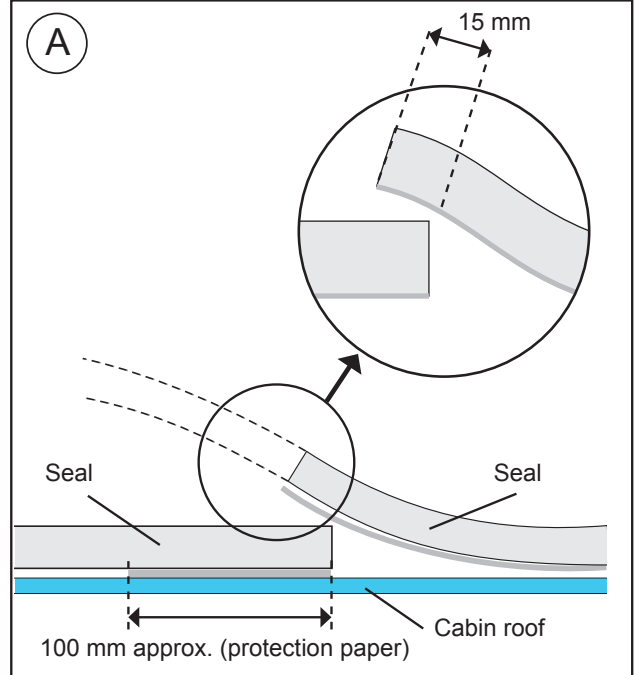

**Important:** The Integral Power II has 4 plates welded to the sides of the base in order to ensure safe lifting using mechanical lifting equipment.

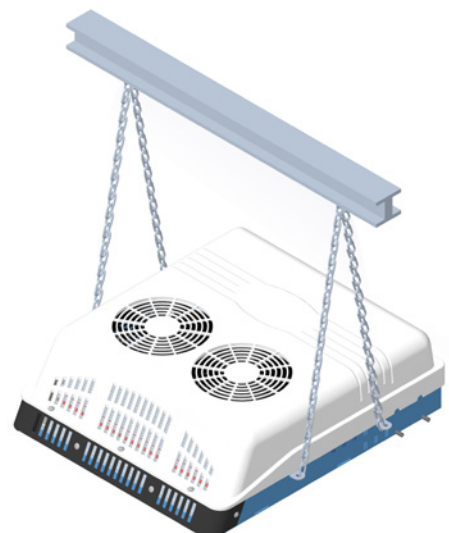
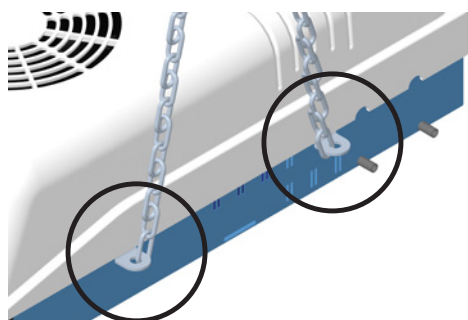



**4** CABIN EXTERIOR:  
Position the **Integral Power II** unit in the hatch gap.

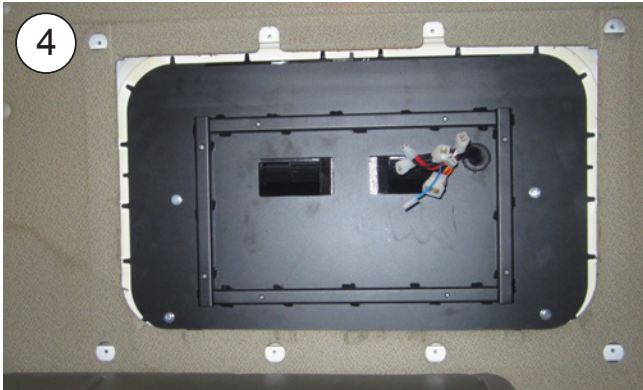
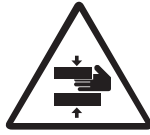

**5** CABIN INTERIOR:  
Thread about 5 mm (4) studs 8 / 125x100-70 or 120 on the threads of the reinforcements indicated (\*), the measurement will be chosen after aligning up the clamping brackets and taking into account that the studs should protrude through the bottom by about 20 mm.

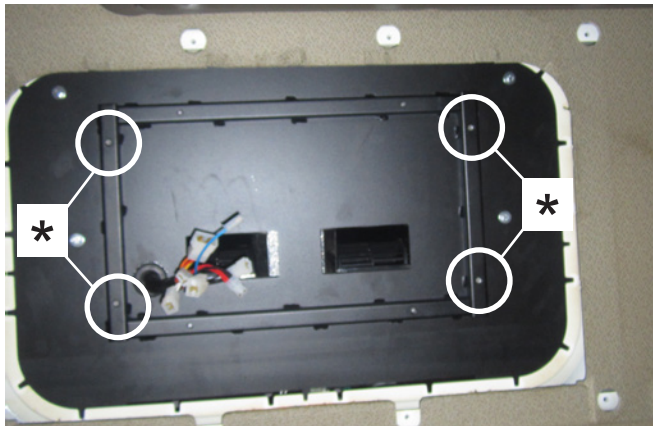
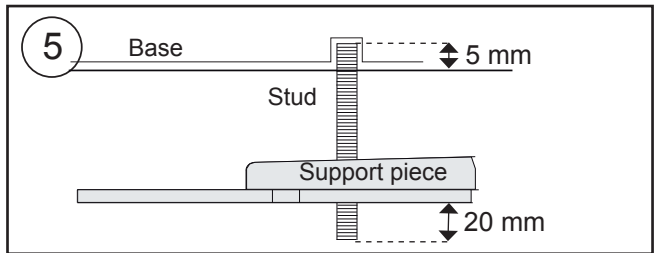

**6** Position (1) Ø7 rubber washer, (1) Ø8 flat wide-rimmed washer, (2) M8 nut and (1) Ø8 flat wide-rimmed washer on each of these studs, in the same order.

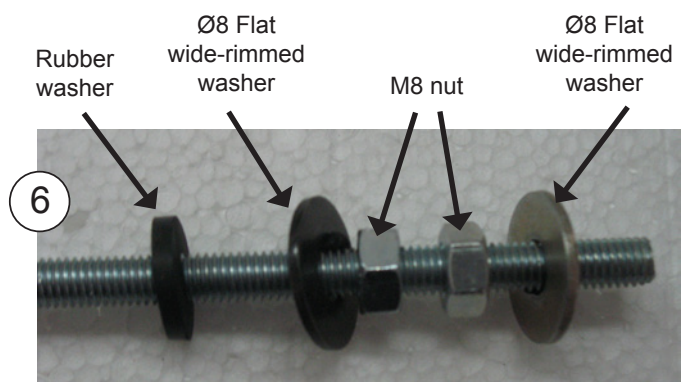

**7** Position (2) fastening supports with (4) washer and (4) M8 self-locking nut, **without fully tightening.**

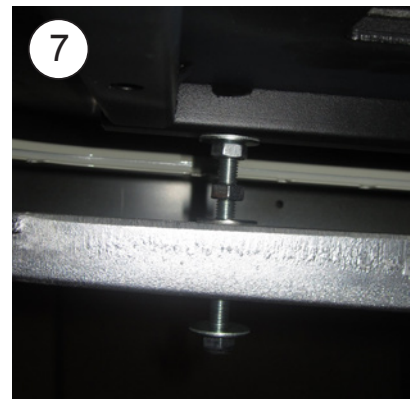

**8** Thread 10 mm (4) M6 x 55 or 80 studs as indicated, in accordance with the distance (D) of the diagram in point 11.

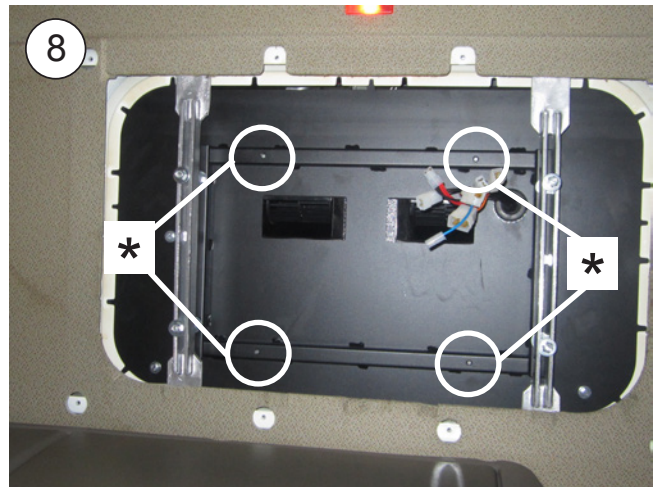

**9** Position (1) Ø6 rubber washer, (1) Ø6 flat wide-rimmed washer and (1) M6 nut on each of the M6 studs. **Tighten the nut** until the rubber washer compresses slightly.

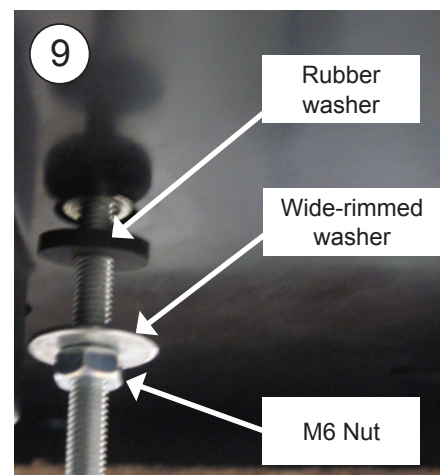

**10** Connect the equipment wiring with inner air distribution panel making the boxes and colours coincide.

**11** Place the inner air distribution panel on the previous studs with (1) wide brimmed M6 washer and (1) M6 nut on each stud. Tighten nuts until channelling duct meets with the upper foam of the equipment.

**Important:** The foam channelling duct must meet the upper foam of the equipment to prevent air leaks.

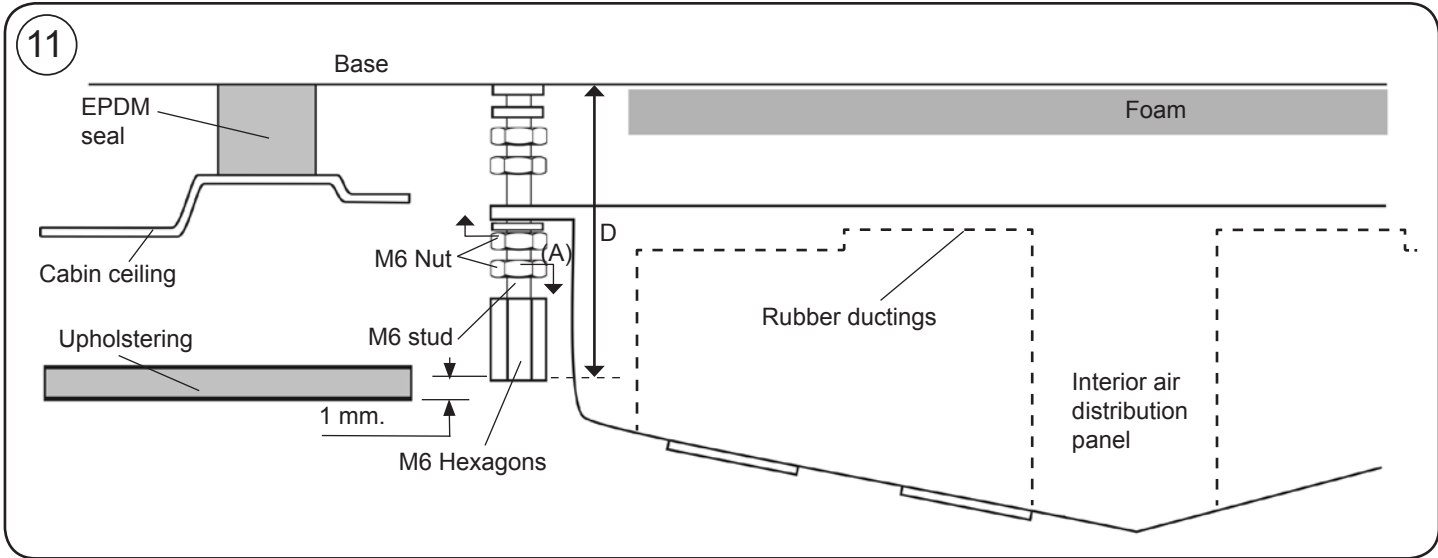

**12** Position the console and align the unit. Once aligned, remove the console.





13

Secure the attachment supports by turning the nuts to tighten the exterior EPDM seal (Point 4) of the unit between 3 mm and 6 mm; the seal should have a thickness of between 19 and 22 mm.

**Important:** To prevent water infiltration into the cabin ensure the tightness of the EPDM seal with the base of the equipment as is shown in the diagram.

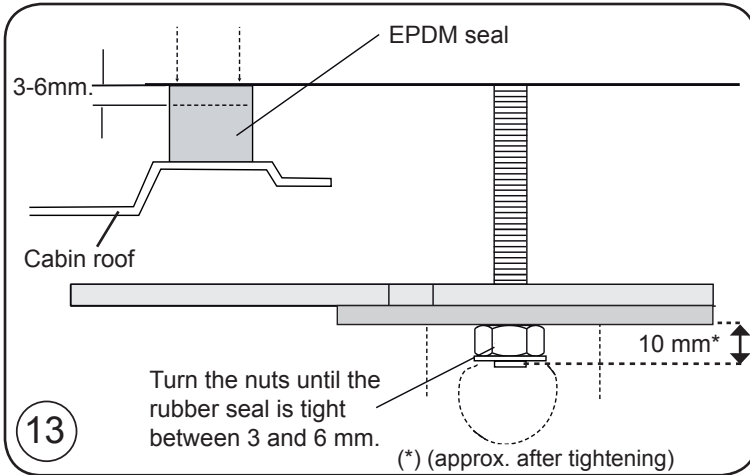
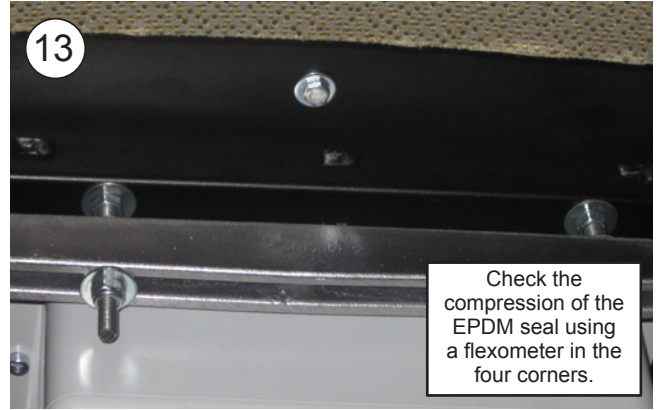

14

Tighten (4) M8 nuts to the bracket and (4) to the base of the equipment.

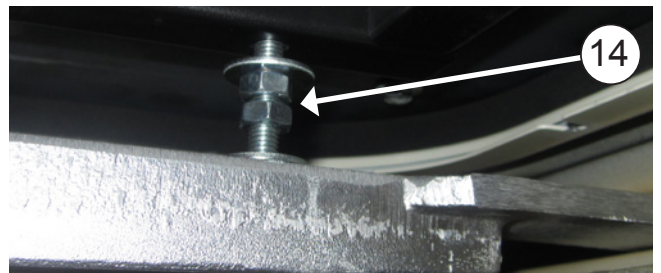



**15** Connect the return air sensor to the screw terminals situated in the air inlet hole.

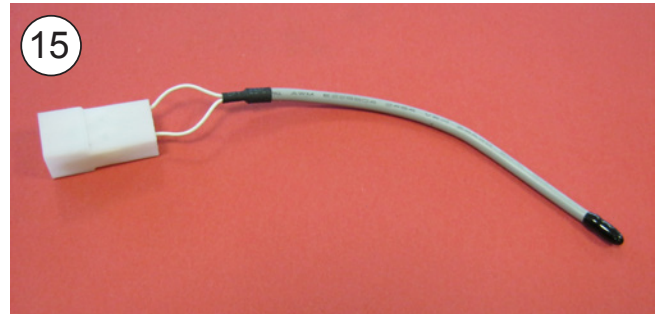

**16** Place nut M6 (A) after the fixing nut of the inner air distribution panel on each stud. Place M6 hexagons screwing until 1 mm above the upholstery. Unscrew nuts M6 (A) from this point until they meet the hex spacers and tighten against them.

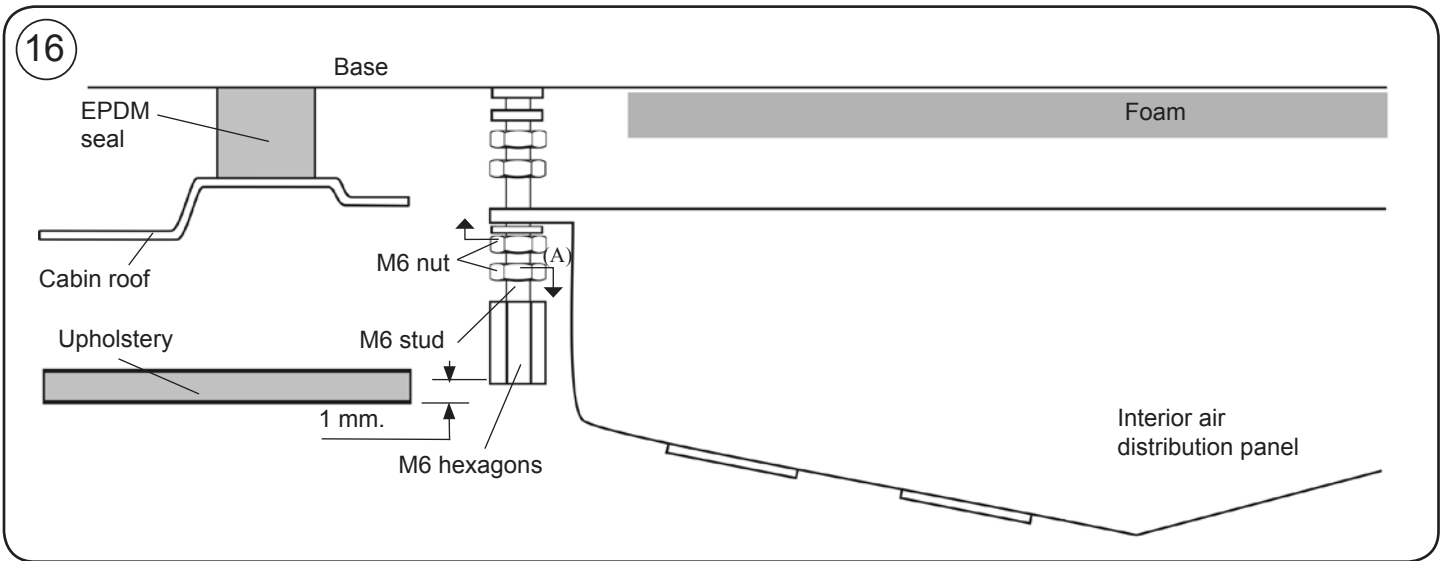
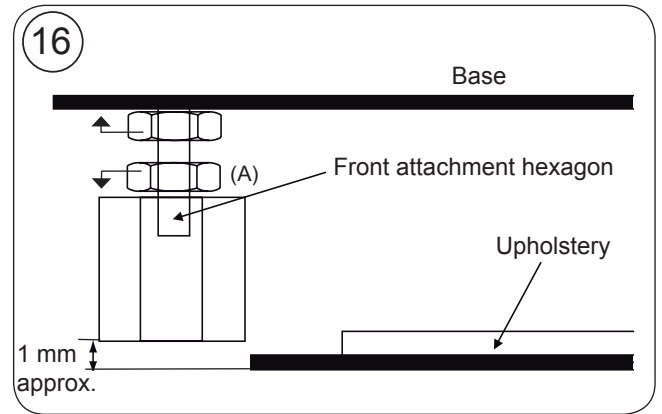

**17** Position the console with (4) M6/100x15 Allen screws.

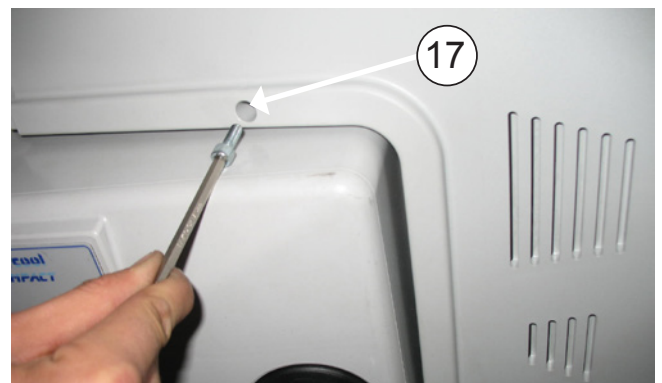

**18** **Caution:** The recirculation sensor must be as indicated to capture the temperature inside the cabin.

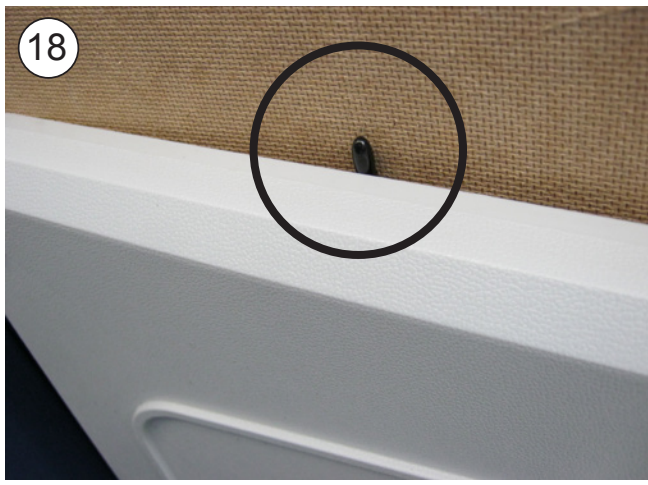

**19** Cover the (4) M6 / 100x15 allen screws with the round plastic trim.



## WASTEWATER PIPES

**1** Mount (4) valves in wastewater pipes.



**2** Secure with (4) clamps and (4) screws as indicated.



**3** Check that they do not interfere with the roof of the cabin, thus ensuring no obstruction.



Detailed instructions on the installation of power supply cables

**4** Connect the upper power cable in the rear of the unit and run to the rear of the cabin, attaching the plastic brackets and securing with flanges.

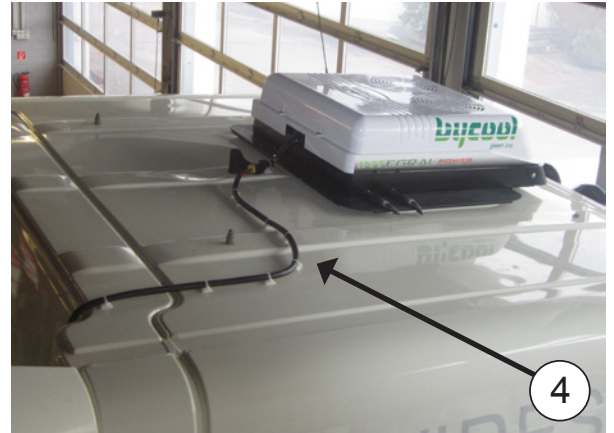
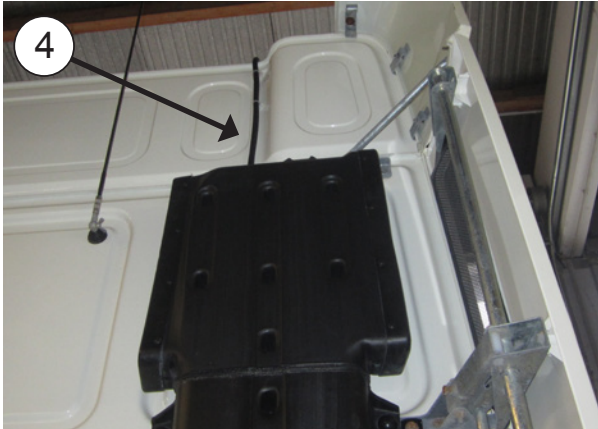

**5** Connect the lower power cable to the battery by running it through the original cabling passage, secured with flanges, to the rear of the cabin and connect to the upper power cable.

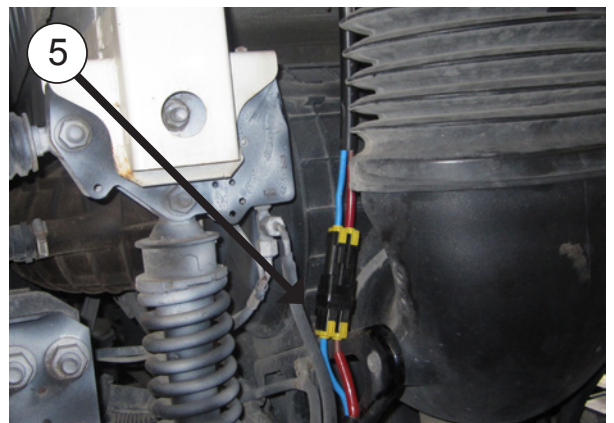
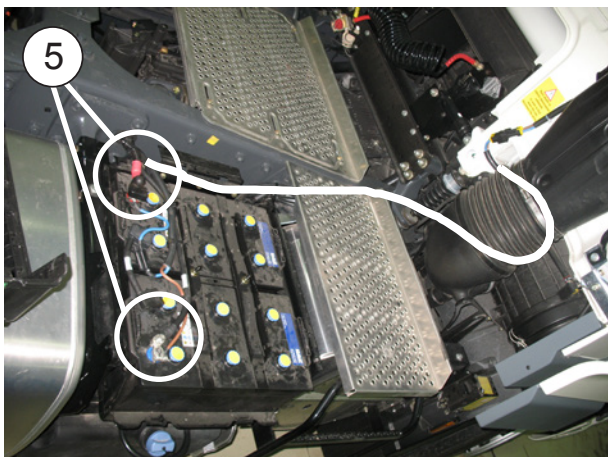



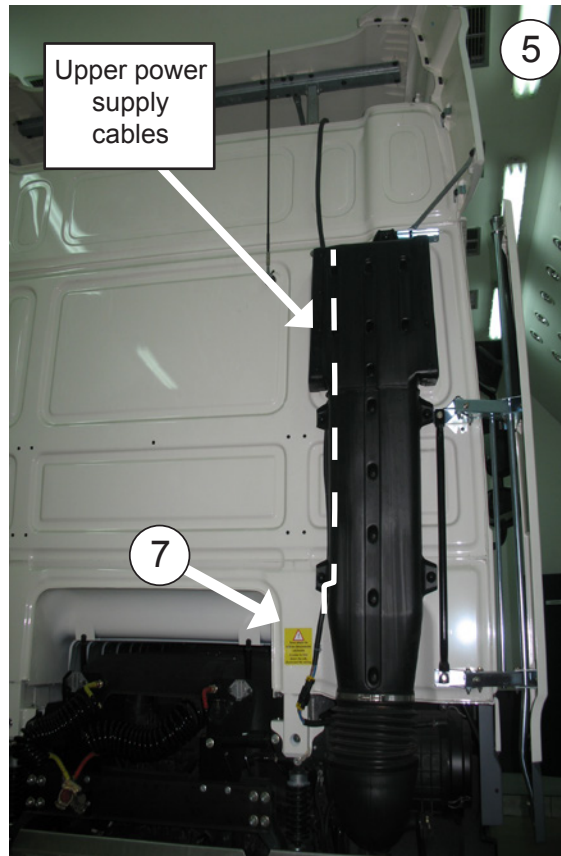

**Important:** When connecting the cables, leave suitable distance in order to prevent breakage when the cabin moves.

6

**Important:** Due to the unit's complex electronic system, the power connection must be made directly to the vehicle's battery.

**Important:** Check the User Manual before starting up.

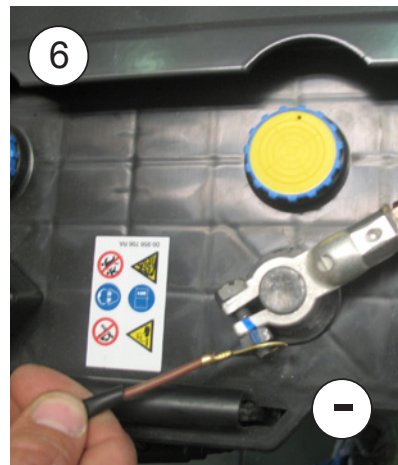
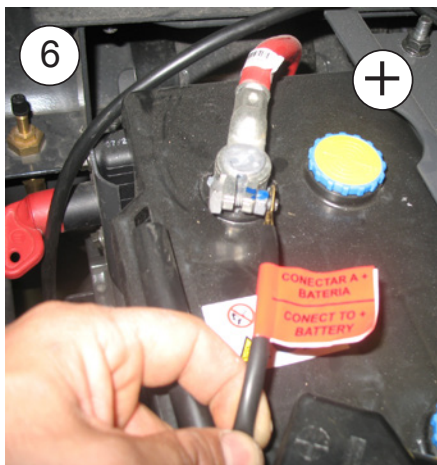

**7** Place danger stickers at the cable joint and on the cabin lifting device.



**Connection to alternator cable for unit operation with the engine running**

 **Caution:** The cable will be installed in all vehicles for the unit to work with the engine started up.

**8** Position excitation cable on the inside or outside of the vehicle as appropriate, and secure the front with the supplied self-tapping screws. Connect switches as shown.

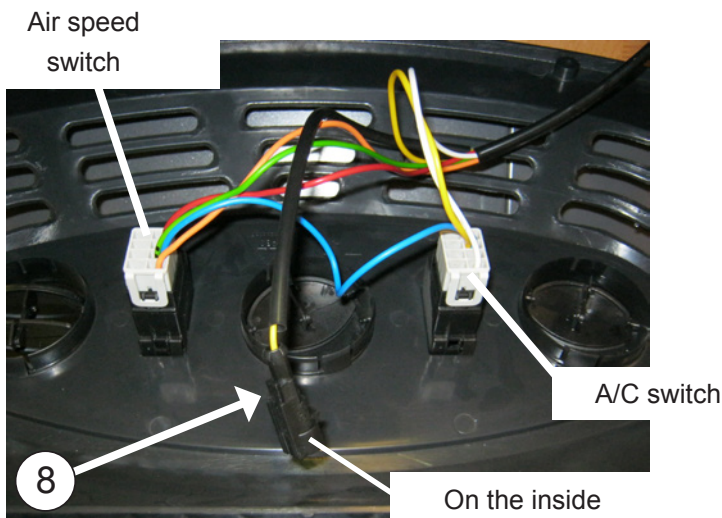
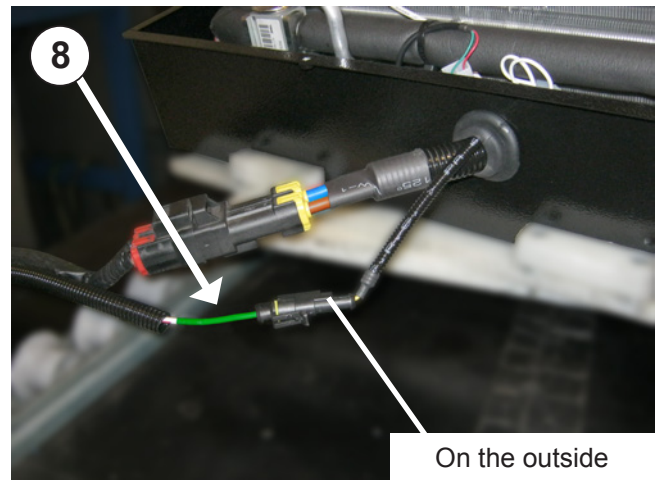

**9**

Connect the other end of the supplied cable in position (+) only with the engine started up or through the (+) ignition key.

**10**

Connect the upper power cable in the rear of the unit.

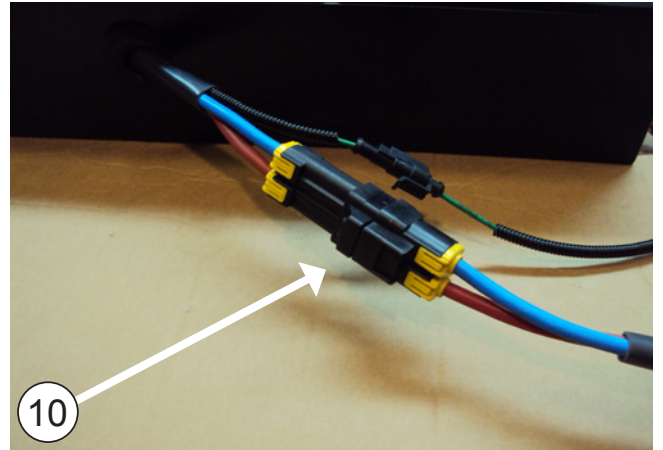

Az	Blue
N	Black
R	Red
V	Green
B	White
A	Yellow
Na	Orange
M	Brown

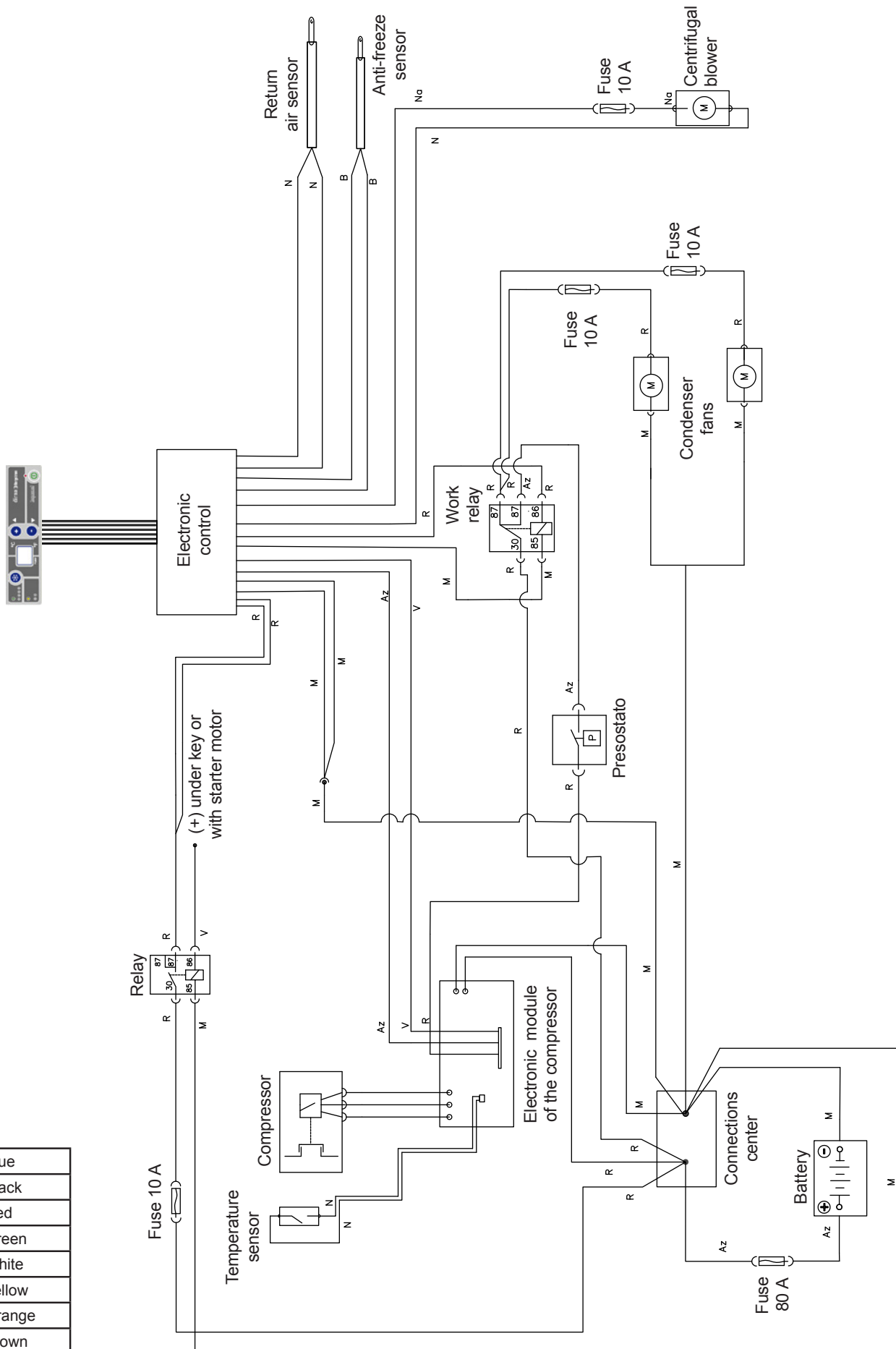





## Recommandations Pour Le Montage

- Avant de commencer le montage de l'appareil, prière de lire les instructions et de les suivre attentivement.
- Utiliser les outils convenant à chaque opération.

## Electricity

- Déconnecter la clé de contact.
- Déconnecter la batterie avant de commencer le montage.
- Vérifier le câblage des composants électriques et leur correcte installation.

### Attention

Si pendant le montage l'équipement est incliné, il faudra attendre au moins 60 minutes avant de le mettre en marche une fois qu'il aura été remis sur sa position horizontale.

### Attention

Lors de l'installation de l'appareil d'air conditionné sur le toit, il faudra protéger la partie supérieure de la cabine avec un linge ou une couverture de protection afin d'éviter les éventuelles égratignures.

Durant l'installation du **Integral Power II**, tenir compte du fait que normalement les cabines pourvues d'écoutille possède une structure suffisamment solide pour supporter le poids de l'appareil. Cependant, si ce n'est pas le cas et qu'il est nécessaire de découper le toit ou même si disposant d'écoutille, la structure n'est pas suffisamment rigide (si elle était en fibre, plastique, etc.) il appartiendra à l'installateur de décider s'il faut renforcer le toit pour éviter toute déformation, rupture ou voie d'eau, etc., et prendre les mesures nécessaires à cet effet.

**Prendre toutes les précautions requises pour les cabines à toit haut en plastique et n'appuyer que sur les nerfs de la cabine afin d'éviter l'affaissement de la pièce en fibre.**

## Outils

Jeu de clés Torx

Jeu de clés Allen

Clé fixe 13

Ciseaux

Mètre

## Documents rattachés

Instructions de montage 1002597509

Guide de l'utilisateur 1002192411

Solution des problèmes 1002192414

Liste de rechanges 1002597510

## Documents joints

Guide rapide 1002455105

Garantie 220AA10017

## Symbologie



Fragile



Attention aux coupures !



Risque électrique

### Garantie



L'installateur devra posséder la formation pertinente en air conditionné sur véhicules.



**Bergstrom** ne sera pas responsable des dommages ou des bris dérivés d'une installation ou d'une manipulation incorrecte ni des modifications réalisées sans autorisation expresse par écrit.



**Appareil pré-chargé de gaz réfrigérant. (Ne pas manipuler le circuit de gaz réfrigérant).**



Voir la **procédure de garantie** du produit au **Diagnostic de problèmes**.



Voir le **Guide de l'Usager** de l'appareil pour le fonctionnement correcte de la télécommande et du tableau de commande.



Après l'installation, vous devez fournir à l'utilisateur: Manuel d'utilisation, garantie et diagnostic de pannes.



**Attention !** Le poids de l'équipement est de 52 Kg.

 **Attention**

Toute modification des systèmes ROPS / FOPS, comme le soudage ou le perçage de trous dans des pièces structurales, affectera la capacité de ROPS / FOPS à fournir la protection requise. L'installation de ce produit peut affecter les systèmes ROPS / FOPS.

Contactez votre distributeur agréé pour vérifier la compatibilité avant d'effectuer des modifications ou des réparations; dans le cas contraire, vous pouvez annuler la certification ROPS / FOPS. Le fabricant du système de climatisation de toit n'assume aucune responsabilité.

**1** Démontez le couvercle de l'écouille, les éléments de fixation et les remettre au client (\*).

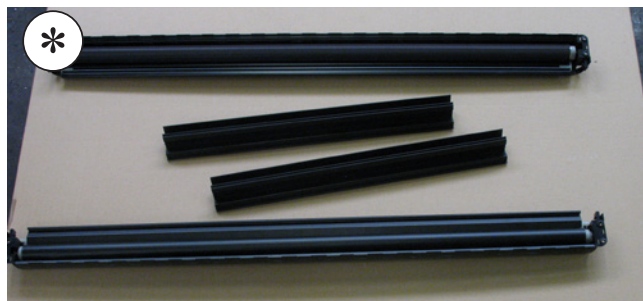

**2** Retirez les résidus adhérents au plafond avant de coller le joint EPDM.

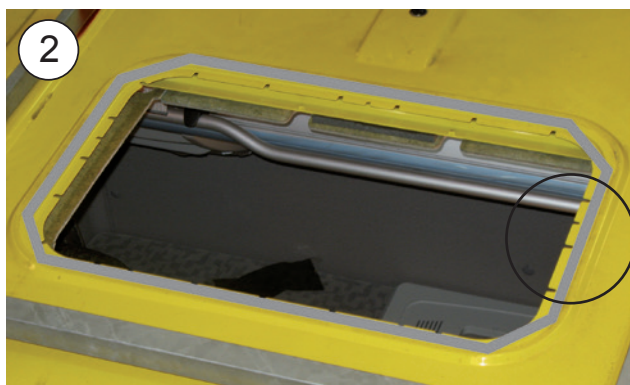

3

Coller le joint EPDM autour du creux de l'écouille (*observer le détail pour couper les bords finaux d'union du joint*).

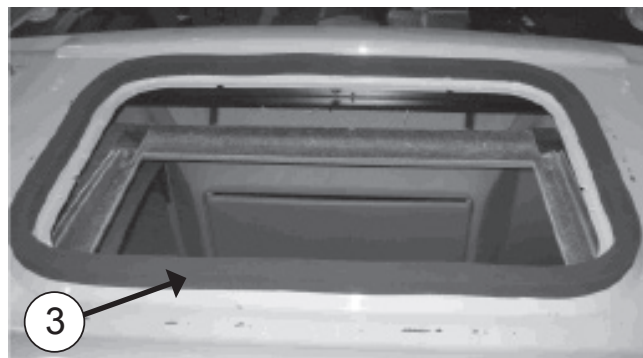

### COMMENT COUPER LE JOINT EPDM POUR ÉVITER LA FILTRATION D'EAU DANS LA CABINE

**A-** Coller le joint en maintenant 100 mm de papier protecteur de chaque côté.

**B-** Retirer les deux pièces de papier.

**C-** Coller en exerçant une pression sur les deux extrémités.

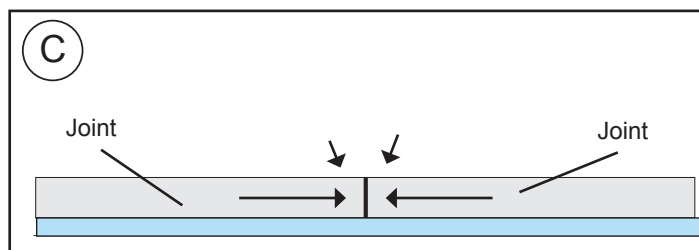
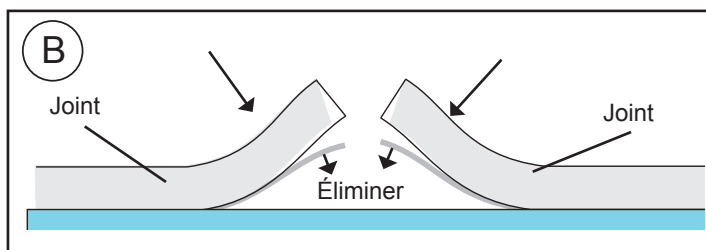
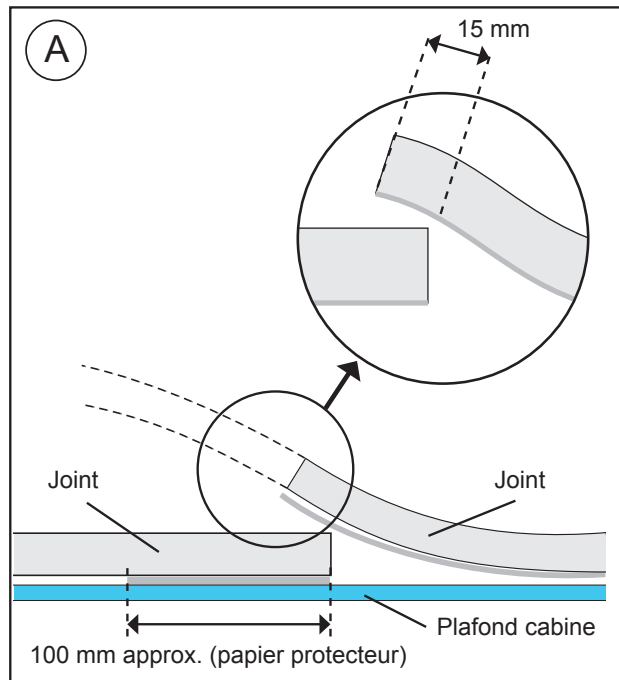

**Important :** L'équipement **Integral Power II** est muni de 4 goussets soudés sur les côtés de la base pour assurer un levage en sécurité au moyen d'un équipement mécanique de levage.

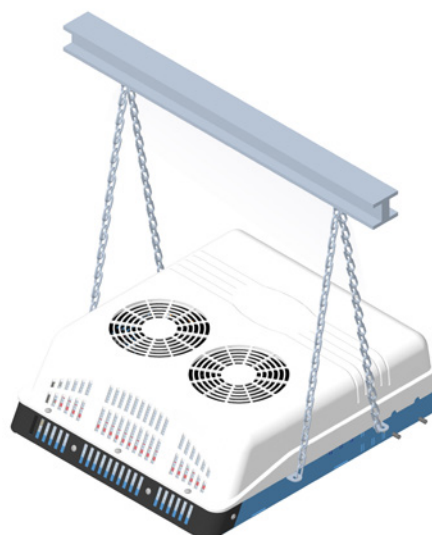
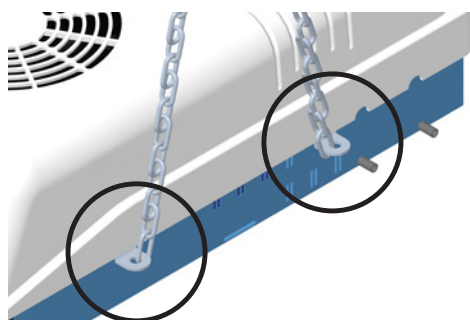



**4** **EXTÉRIEUR CABINE:**  
Placer l'équipement **Integral Power II** dans le creux de l'écouille.

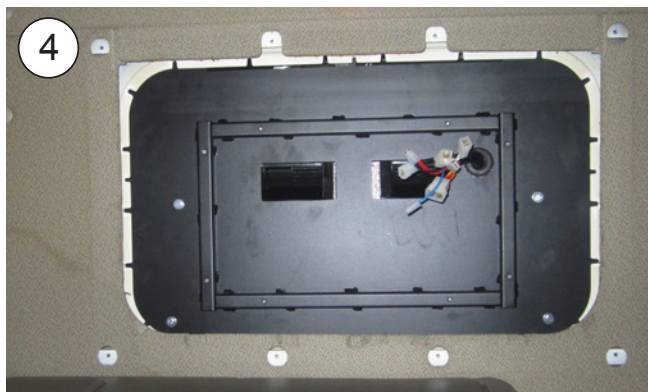

**5** **INTÉRIEUR CABINE :**  
Visser d'environ 5 mm (4) goujons 8/125x100-70 ou 120 dans les écrous des renforts indiqués (\*). La mesure sera choisie après avoir présenté les supports de fixation et en tenant compte que les goujons doivent ressortir de ceux-ci d'environ 20 mm par la partie inférieure.

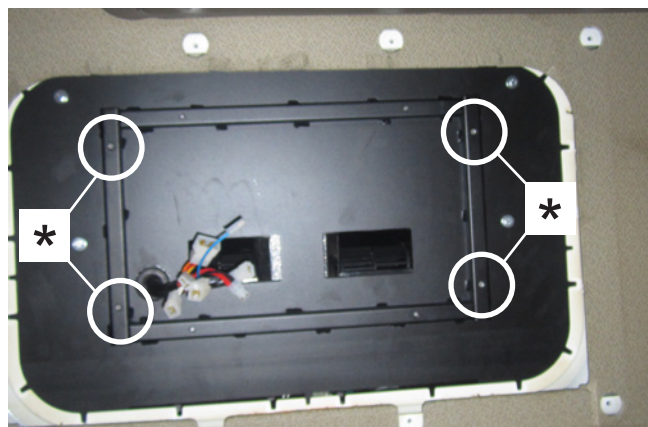
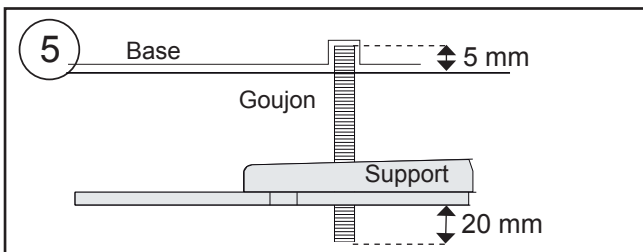

**6** Placer (1) rondelle Ø 7 en caoutchouc, (1) rondelle plate Ø 8 surface large, (2) écrous M8 et (1) rondelle plate Ø 8 surface large dans chacun des goujons précédents. Suivre l'ordre indiqué.

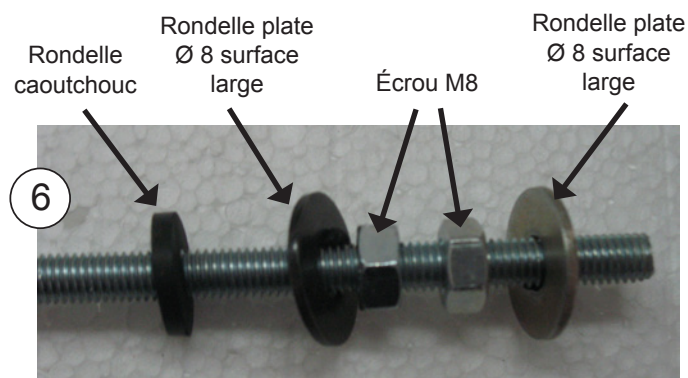

- 7** Placer (2) supports de fixation avec (4) rondelles et (4) écrous autobloquants M8, sans serrer.

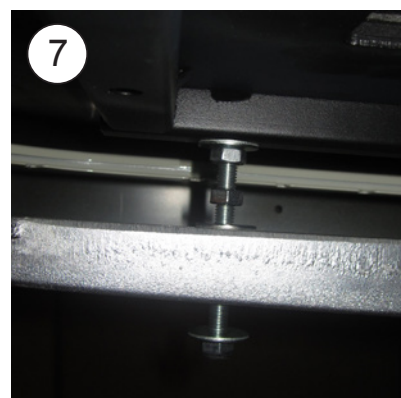
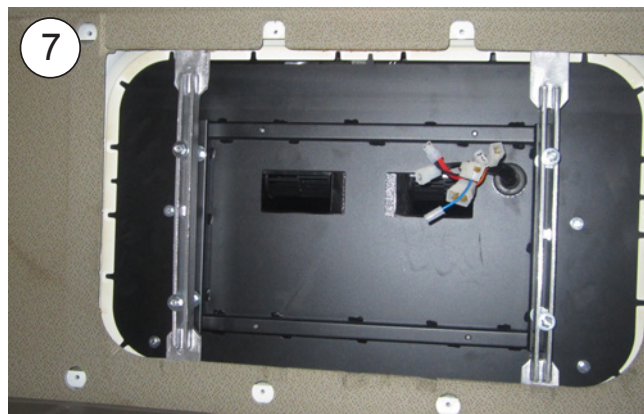

- 8** Visser 10 mm (4) goujons M6 x 55 ou 80, à l'endroit indiqué, selon la distance (D) du schéma du point 11.

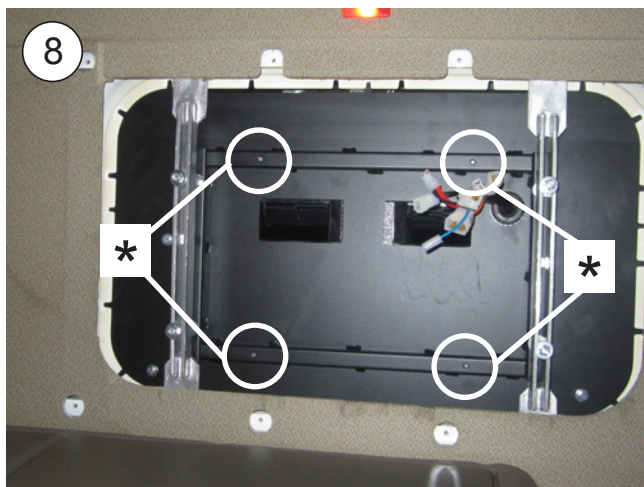

- 9** Placer (1) rondelle Ø6 en caoutchouc, (1) rondelle plate Ø6 surface large et (1) écrou M6 sur chaque goujon de M6. **Serrer l'écrou** jusqu'à ce que la rondelle en caoutchouc reste légèrement opprimée.

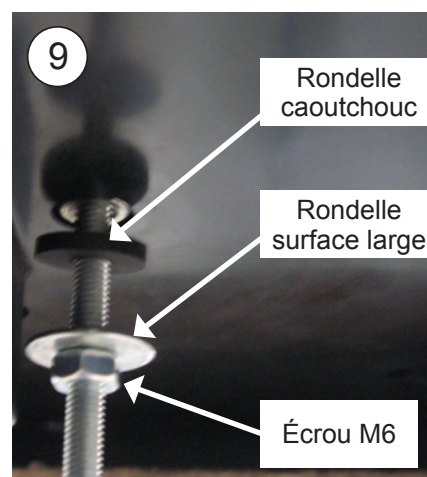

**10** Connecter les câblages de l'équipement à ceux du panneau intérieur de distribution d'air en faisant coïncider les boîtiers et les couleurs.

**11** Placer le panneau intérieur de distribution d'air dans les goujons précédents avec (1) rondelle M6 surface large et (1) écrou M6 sur chaque goujon. Serrer les écrous jusqu'à ce que les canalisateurs heurtent le caoutchouc mousse supérieur.

**Important:** Les canalisateurs doivent heurter le caoutchouc mousse supérieur pour éviter des fuites d'air.

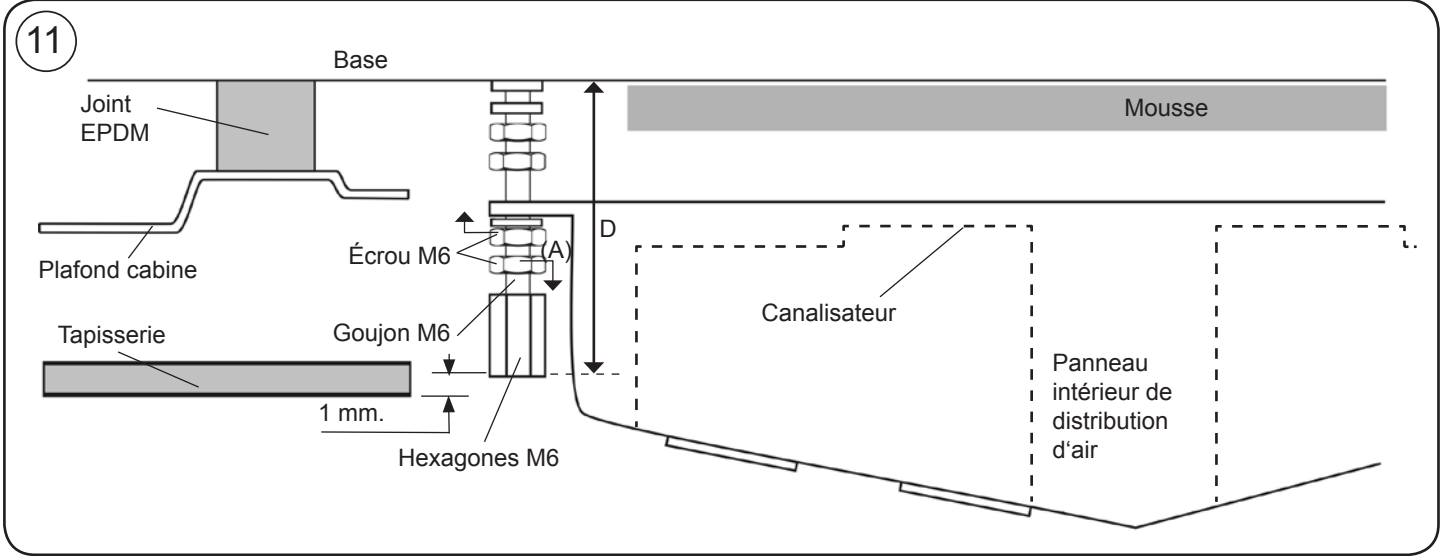

**12** Présenter la console et centrer l'équipement. Ensuite, retirer la console.





**13**

Fixer les supports de fixation en serrant les écrous jusqu'au serrage du joint en EPDM extérieur (Point 4) de l'équipement entre 3 et 6mm ; le joint doit présenter une épaisseur comprise entre 19 et 22 mm.

**Important:** Pour éviter de possibles filtrations d'eau à l'intérieur de la cabine, il faut assurer le serrage du joint EPDM à la base de l'équipement, comme indique le schéma.

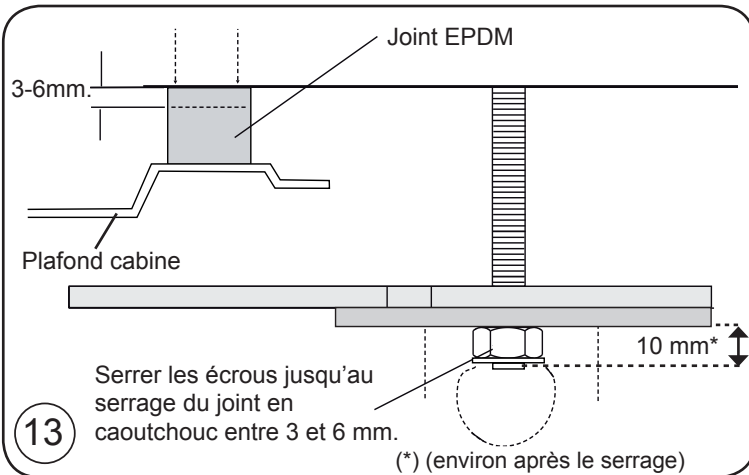
**14**

Serrer (4) écrous M8 au support et (4) à la base de l'équipement.

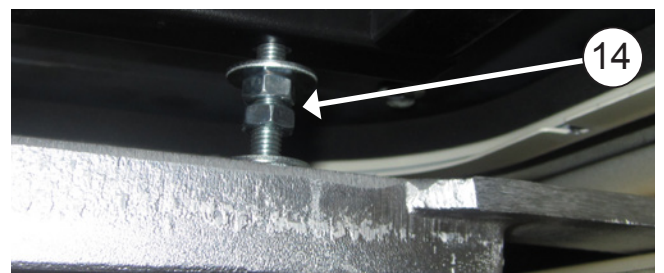



**15** Connecter le capteur d'air de retour à la borne placée dans le creux de l'entrée d'air.



**16** Placer un écrou M6 (A) après l'écrou de fixation du panneau intérieur de distribution d'air dans chaque goujon. Placer les hexagones M6 en vissant jusqu'à ce qu'il reste 1 mm au-dessus de la tapisserie. Dévisser les écrous M6 (A) de ce point jusqu'à atteindre les hexagones et serrer contre eux.

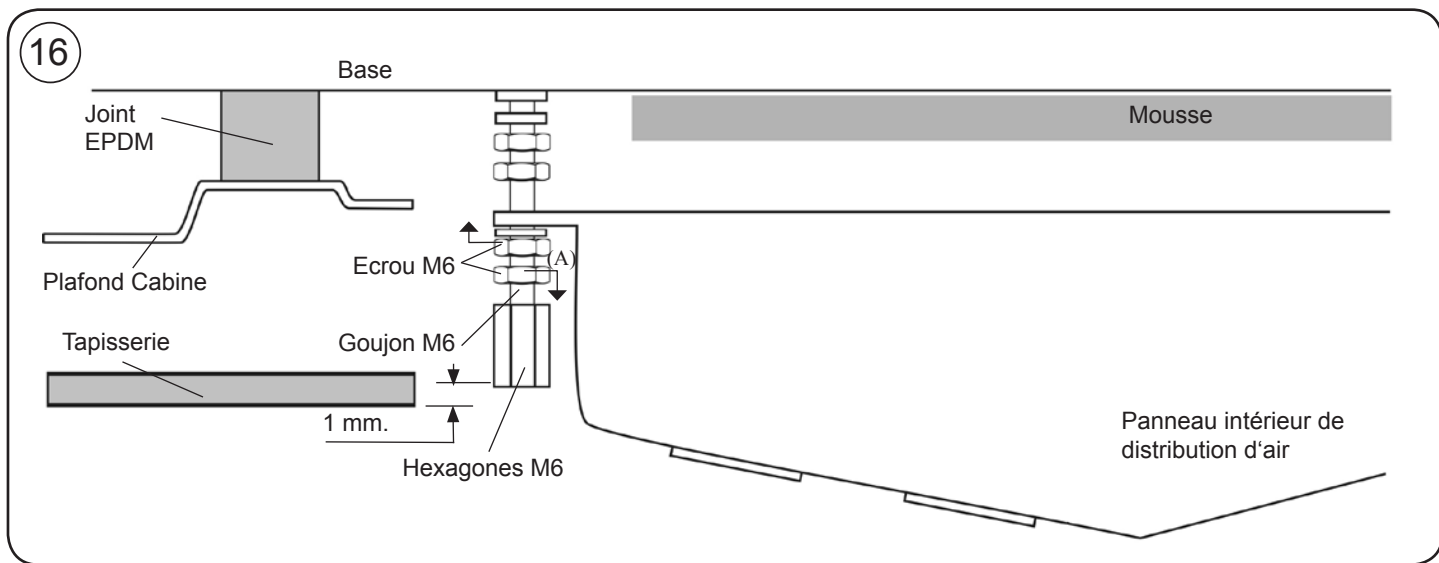
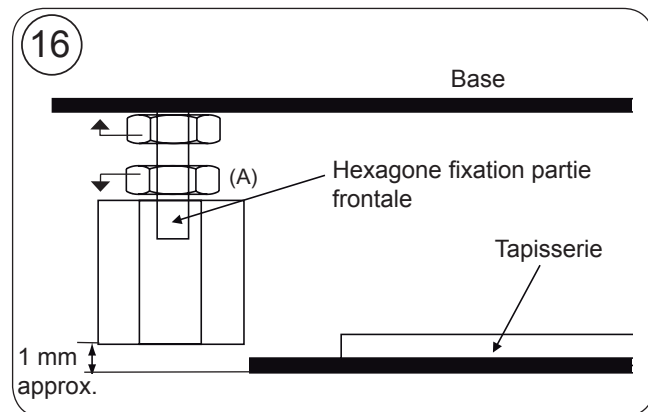

**17** Placer la console avec (4) vis M6/100x15 allen.

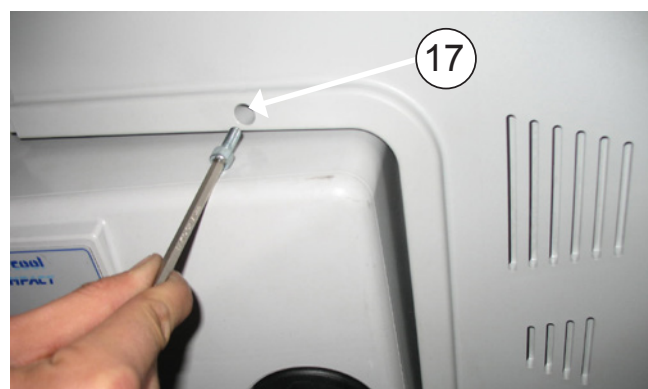

18

**Attention** : la sonde de recirculation devra être placée tel que cela est indiqué pour lui permettre de capter la température de l'intérieur de la cabine.



19

Couvrir les (4) vis M6/100x15 allen avec les enjoliveurs ronds en plastique.



## TUYAUX D'ÉCOULEMENT

- 1** Monter (4) vannes dans les tuyaux d'écoulement.



- 2** Fixer avec (4) anneaux de serrage et (4) vis, tel que cela est indiqué.



- 3** Vérifier qu'ils n'interfèrent pas avec le plafond de la cabine, pour éviter une obstruction.



## Instructions détaillées sur l'installation du câblage d'alimentation

- 4** Connecter le câble d'alimentation supérieur à la partie arrière de l'équipement et le porter par la partie postérieure de la cabine en collant les supports en plastique et en le fixant avec des brides.

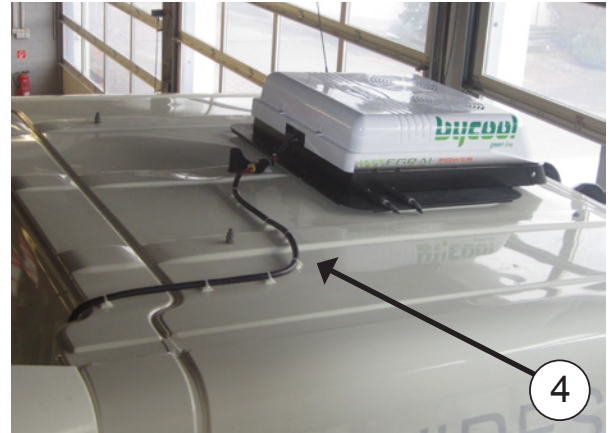
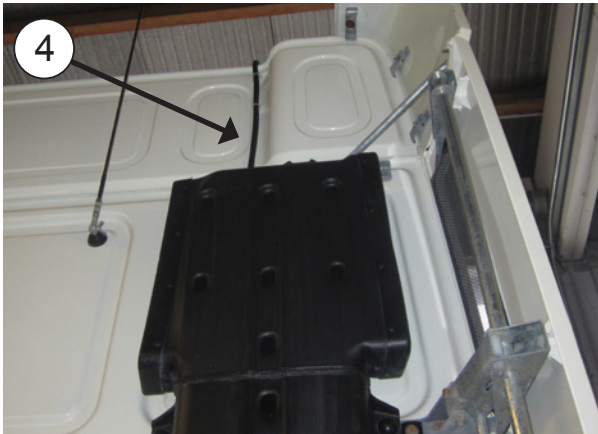

- 5** Connecter le câble d'alimentation inférieur à la batterie, en le portant par le passage original des câbles, fixé avec des brides, vers la partie postérieure de la cabine, pour une connexion avec le câble d'alimentation supérieur.

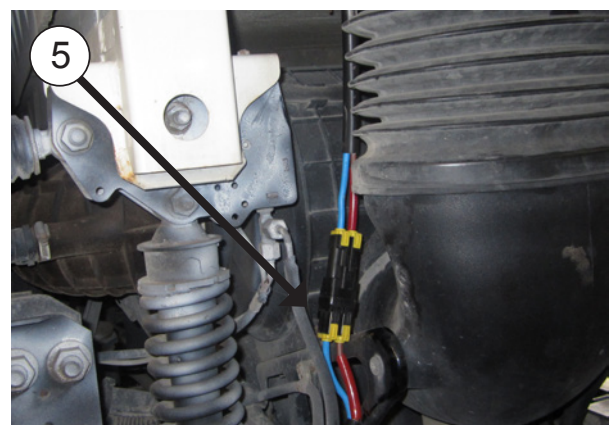
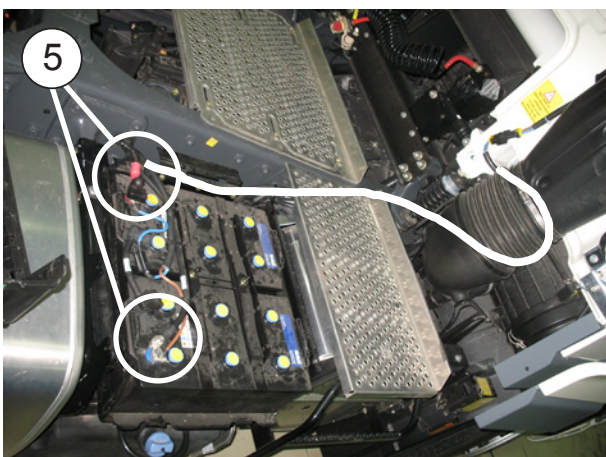



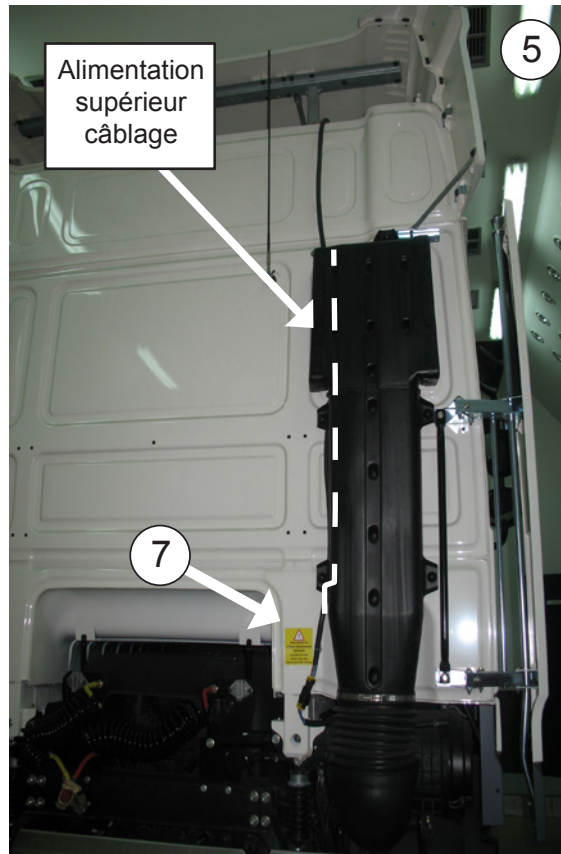

Alimentation supérieur câblage

5

7

 **Important:** Au moment de la connexion des câblages, prévoir une distance suffisante pour éviter des cassures à cause des mouvements de la cabine.

**6** **Important:** en raison de la complexité du système de réglage électronique de l'équipement, la prise de courant doit être directement effectuée à la batterie du véhicule.  
**Important:** Pour la mise en marche, consultez la notice.

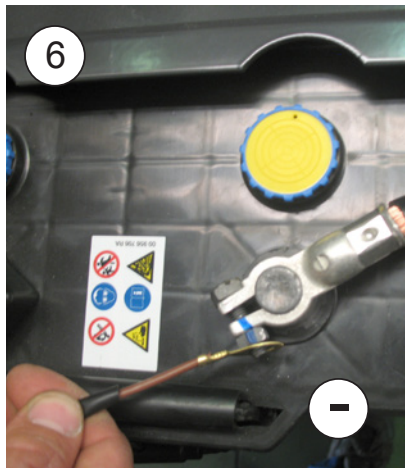
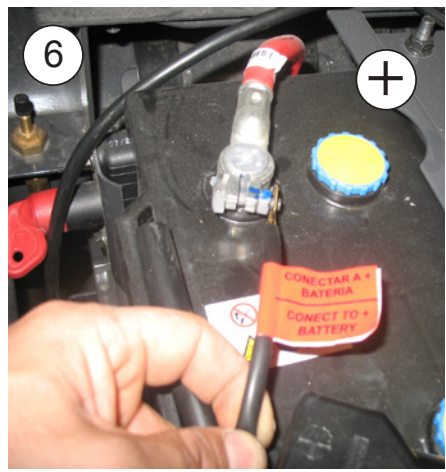

- 7** Placer les adhésifs de danger dans l'union de câblage et dans le dispositif de levage de la cabine.



## Câblage de connexion à alternateur pour fonctionnement équipement avec moteur en marche



**Attention:** le câblage sera installé dans tous les véhicules pour que l'équipement fonctionne avec le moteur démarré.

**8**

Placer le câblage d'excitation à l'intérieur ou à l'extérieur du véhicule et monter avec les vis taraudeuses fournies. Connecter les interrupteurs comme cela est indiqué.

Interrupteur vitesses air

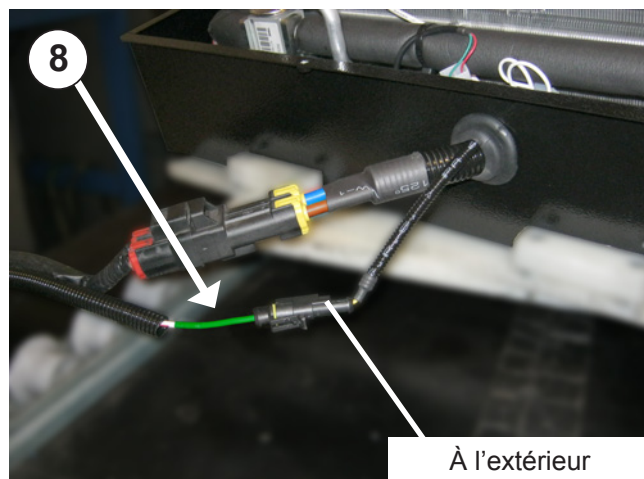
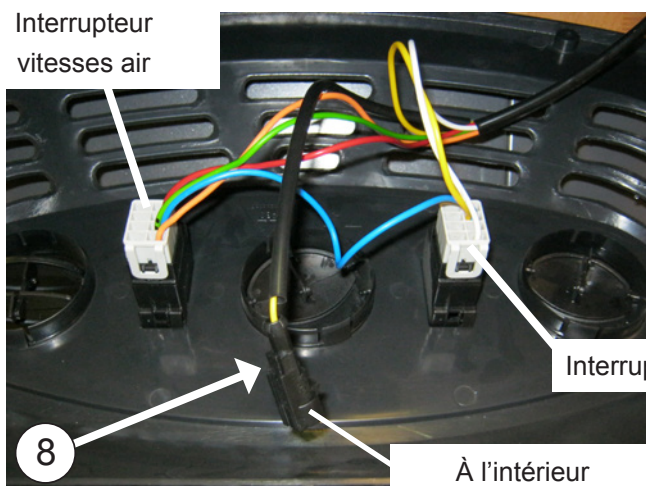

**9**

Connecter l'autre extrémité du câblage fourni sur la position (+) uniquement avec le moteur démarré ou à travers (+) clé de contact.

**10**

Connecter le câble d'alimentation supérieur à la partie arrière de l'équipement.

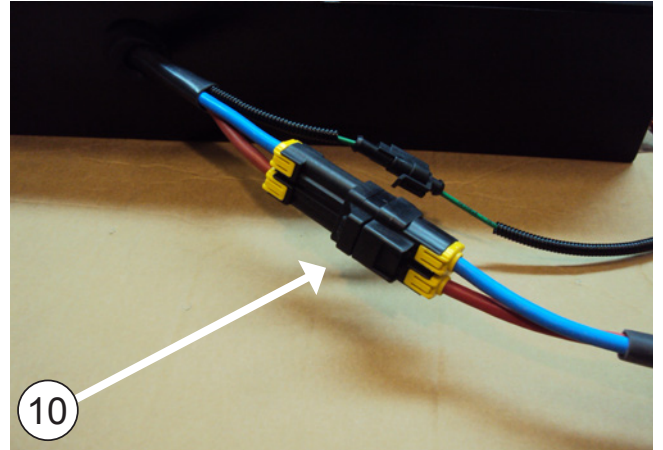

Câblage électrique

Az	Bleu
N	Noir
R	Rouge
V	Vert
B	Blanc
A	Jaune
Na	Orange
M	Marron

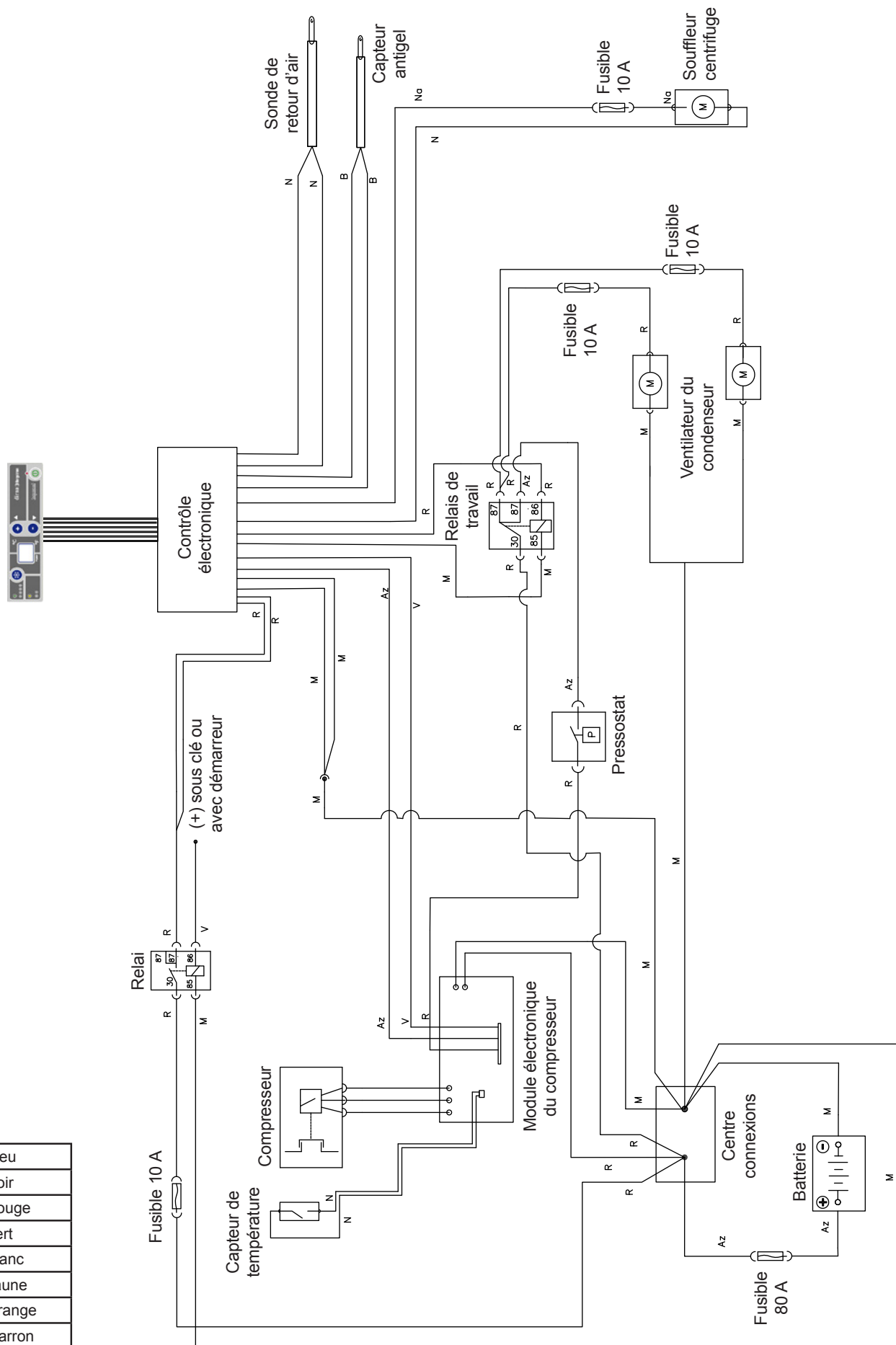





## Empfehlungen Zur montage

- Vor und während der Montage bitte diese Anweisungen lesen und beachten.
- Benutzen Sie für jeden Arbeitsschritt die geeigneten Werkzeuge.

## Elektrizität

- Zündschlüssel abziehen.
- Vor Montagebeginn die Batterie abklemmen.
- Den ordnungsgemäßen Anschluss und die korrekte Installation der Elektrokomponenten überprüfen.

## Achtung

Sollte sich das Gerät während der Montage neigen, muss man mindestens 60 Minuten warten, nachdem es wieder in die horizontale Lage gebracht wurde, um es wieder einzuschalten.

## Achtung

Wird die Klimaanlage im Kabinendach installiert, muss der obere Teil der Kabine mit einem Tuch oder einer Decke gegen eventuelle Kratzer geschützt werden. Bei der Installation der **Integral Power II** auf dem Kabinendach muss darauf geachtet werden, dass mit Luken ausgestattete Kabinen über eine ausreichend stabile Struktur verfügen, um das Gewicht des Geräts stand zu halten. Sollte das Fahrzeug über keine Luke verfügen und sollte es notwendig sein, das Kabinendach aufzuschneiden, bzw. sollte die vorhandene Struktur nicht ausreichend stabil sein (z.B. wenn sie aus Faser, Kunststoff usw. hergestellt ist), obliegt es dem Installateur zu entscheiden, ob das Kabinendach zur Vermeidung von Verformungen, Brüchen, undichten Stellen usw. verstärkt werden muss, und die hierfür notwendigen Mittel bereit zu stellen.

**Bei Kabinen mit hohem Kunststoffdach des entsprechenden Vorsichtsmaßnahmen treffen und das Gerät nur auf den Rippen der Kabine lagern, um das Einsacken des Faserteils zu vermeiden.**

## Werkzeuge

- Torx-Schraubenschlüssel
- Inbusschraubenschlüssel
- 13er Schraubenschlüssel
- Schere
- Metermaß

## Zugehörige Dokumentation

Montageanweisungen	1002597509
Benutzerleitfaden	1002192411
Fehlerdiagnose	1002192414
Ersatzteilliste	1002597510

## Enthaltene Dokumentation

Kurzführer	1002455105
Garantie	220AA10017

## Symbologie



Fragile



Attention aux coupures !



Risque électrique

## Warnhinweise



Der Installateur muss im Bereich Fahrzeug-Klimaanlagen ausreichend geschult sein.



**Bergstrom** übernimmt keine Verantwortung für Schäden oder Brüche aufgrund einer nicht ordnungsgemäßen Installation oder Bedienung des Geräts oder den Austausch von Teilen bzw. Umbauten, die ohne die erforderliche schriftliche Genehmigung durchgeführt wurden.



**Mit Kältemittel vorgefülltes Gerät. (Kältemittelkreislauf nicht manipulieren).**



Siehe **Garantieverfahren** des Produkts in der **Fehlerdiagnose**.



Siehe **Benutzerleitfaden** des Geräts für den ordnungsgemäßen Betrieb der Fernbedienung und des Bedienfelds.



Die folgenden Unterlagen müssen dem Benutzer nach der Installation ausgehändigt werden: **Benutzerleitfaden**, **Garantie** und **Fehlerdiagnose**.



**Achtung!** Anlagengewicht 52 kg

 **Warnhinweise**

Jegliche Modifikation bezüglich ROPS/FOPS, wie zum Beispiel das Schweißen oder das Bohren von Löchern in tragenden Teilen, beeinflusst die ROPS/FOPS-Kapazität, den gewünschten Schutz bereitzustellen. Die Installation dieses Produktes kann sich auf die ROPS/FOPS-Systeme auswirken.

Wenden Sie sich an Ihren autorisierten Händler, um die Kompatibilität zu überprüfen, bevor Sie irgendwelche Modifikationen oder Reparaturen durchführen. Andernfalls kann die ROPS/FOPS-Zertifizierung ungültig werden. Der Hersteller der Dach-Klimaanlage übernimmt keinerlei Haftung.

**1** Lukendeckel und dessen Befestigungselemente ausbauen und diese dem Kunden aushändigen (\*).



**2** Vor dem Ankleben der EPDM-Dichtung an der Decke klebende Reste entfernen.

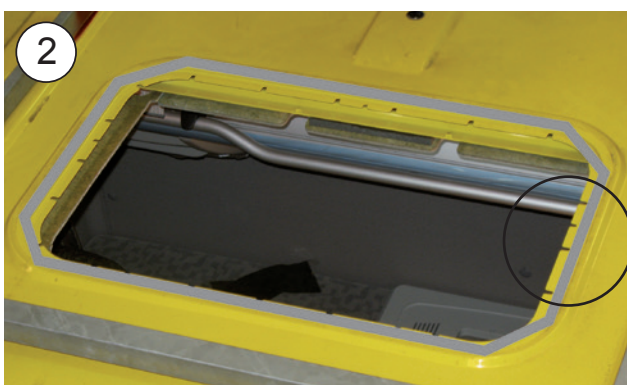

**3** Die EPDM-Dichtung um die Lukenausparung herum kleben (siehe Detailzeichnung für das Zurechtschneiden der äußeren Verbindungsränder).

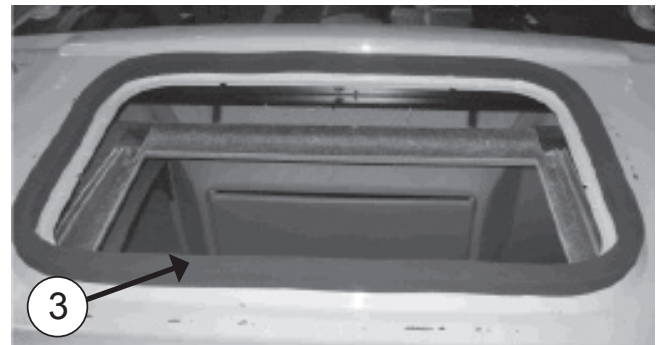

**ZURECHTSCHNEIDEN DER EPDM-DICHTUNG ZUR VERMEIDUNG DES EINDRINGENS VON WASSER IN DIE KABINE**

**A-** Dichtung ankleben, dabei auf jeder Seite 100 mm Schutzpapier stehen lassen.

**B-** Die zwei Papierstücke entfernen.

**C-** Beide Enden durch Andrücken ankleben.

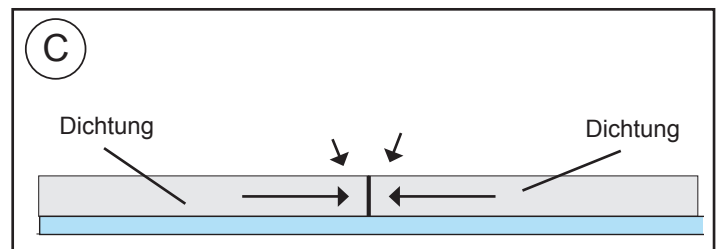
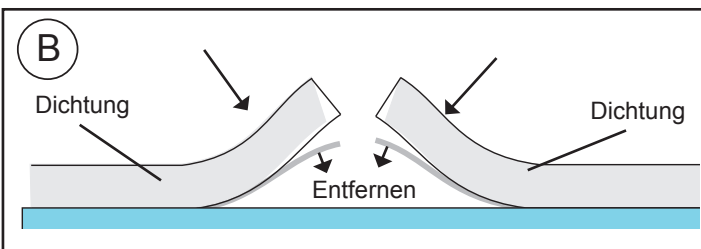
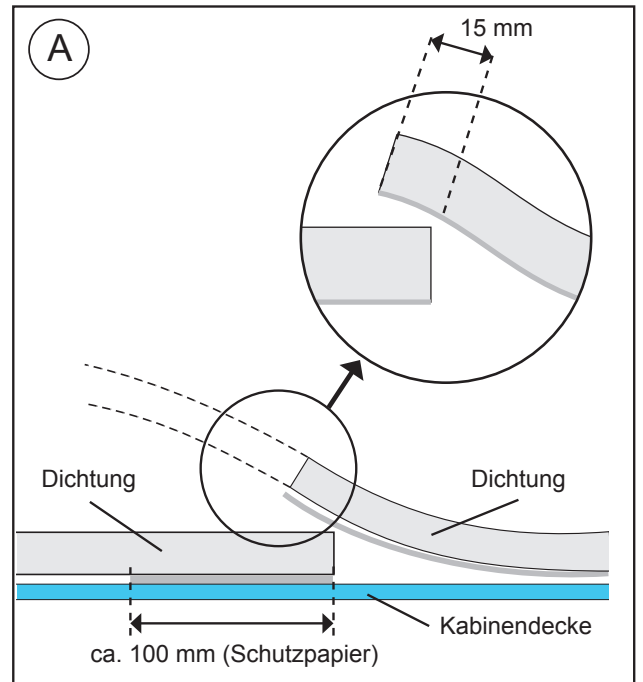

**Wichtiger Hinweis:** Das Gerät **Integral Power II** hat 4 seitlich am Sockel angeschweißte Lochlaschen, um ein sicheres Anheben mit einer mechanischen Hebevorrichtung zu ermöglichen.

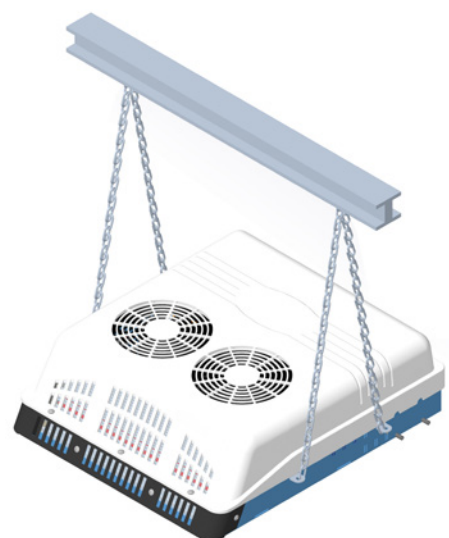
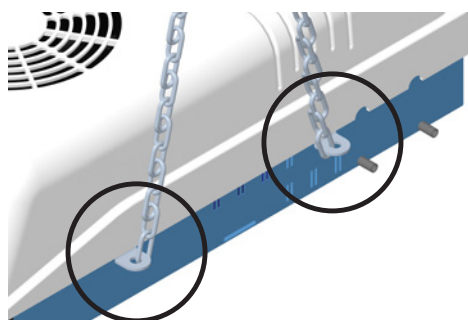



**4** AUSSENSEITE KABINE:  
Integral Power II in der Lukenaussparung positionieren.

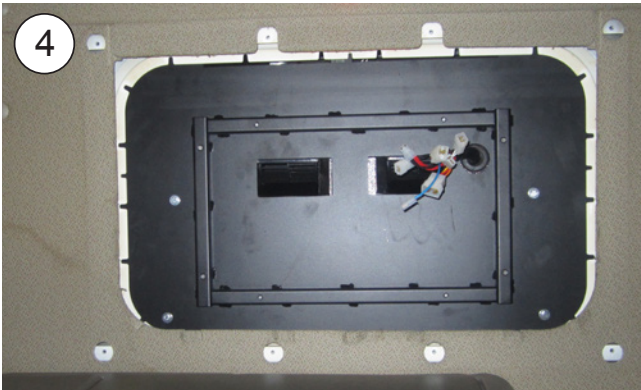

**5** KABINENINNENSEITE:  
(4) Stiftschrauben 8/125x100-70 bzw. 120 ca. 5 mm tief in die Windungen der angegebenen Verstärkungen (\*) schrauben. Das Maß wird gewählt, nachdem die Befestigungshalterungen aufgelegt worden sind und unter Berücksichtigung der Tatsache, dass die Stiftschrauben aus diesen auf der Unterseite etwa 20 mm herausstehen müssen.

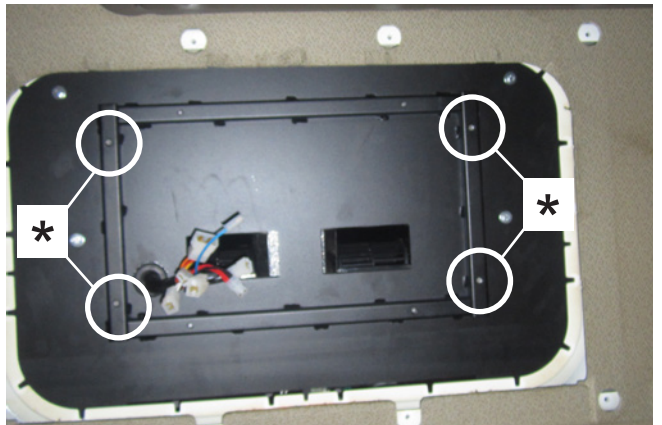
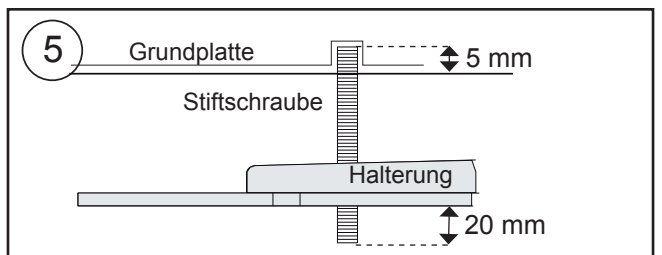

**6** An jeder Stiftschraube (1) Gummiunterlegscheibe Ø 7, (1) Breitflansch-Flachscheibe Ø 8, (2) Muttern M8 und (1) Breitflansch-Flachscheibe Ø 8 in der angegebenen Reihenfolge anbringen.

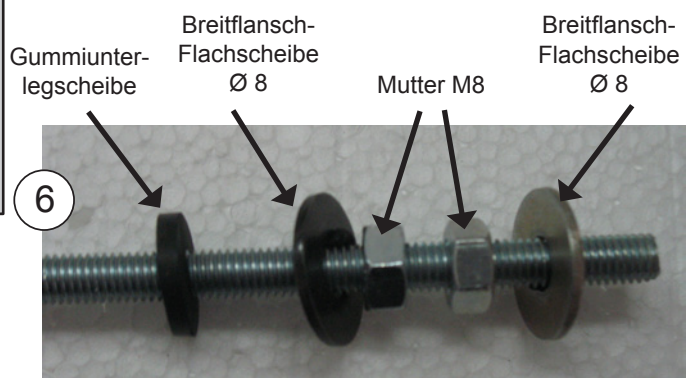

**7** (2) Befestigungshalterungen mit (4) Unterlegscheibe und (4) selbstsichernder Mutter M8 anbringen, **ohne diese festzuziehen.**

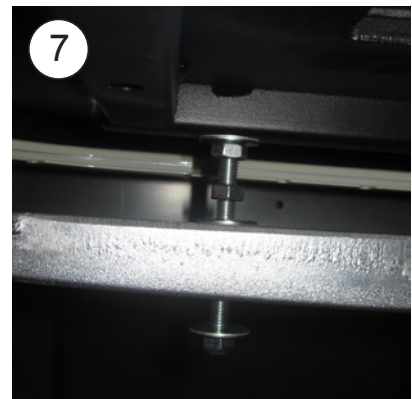

**8** 10 mm (4) Stiftschrauben M6 x 55 ó 80 an den angegebenen Stellen je nach Abstand (D) des Schemas in Punkt 11 eindrehen.

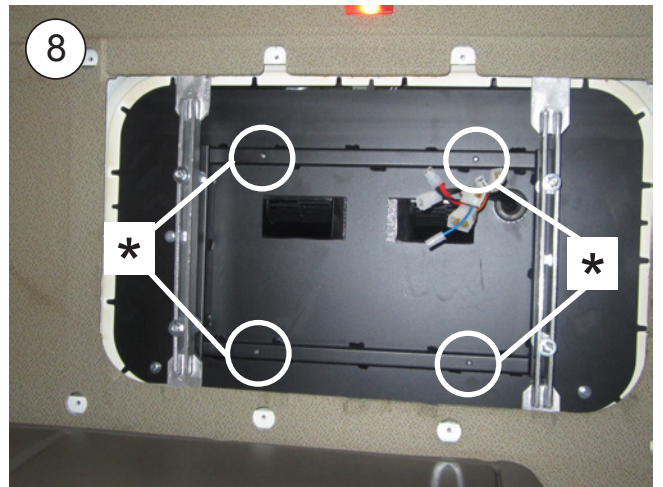

**9** (1) Gummiunterlegscheibe Ø6, (1) Breitflansch-Flachscheibe Ø6 und (1) Mutter M6 auf jede Stiftschraube M6 legen. Mutter anziehen, danach **Mutter anziehen**, bis die Gummiunterlegscheibe ein wenig zusammengedrückt wird.

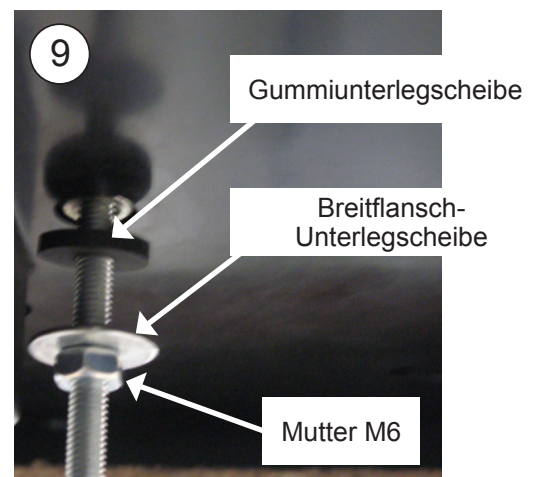

**10** Kabel des Geräts an die der inneren Luftverteiltertafel anschließen, wobei Kästen und Färben übereinstimmen müssen.

**11** Innere Luftverteiltertafel an den vorgenannten Stiftschrauben mit jeweils (1) Breitflansch-Unterlegscheibe M6 und (1) Mutter M6 anbringen. Muttern anziehen, bis die Führungen an den oberen Schaumstoff anstoßen.

**Wichtiger Hinweis:** Die Führungen müssen gegen den oberen Schaumstoff anstoßen, um das Entweichen von Luft zu verhindern.

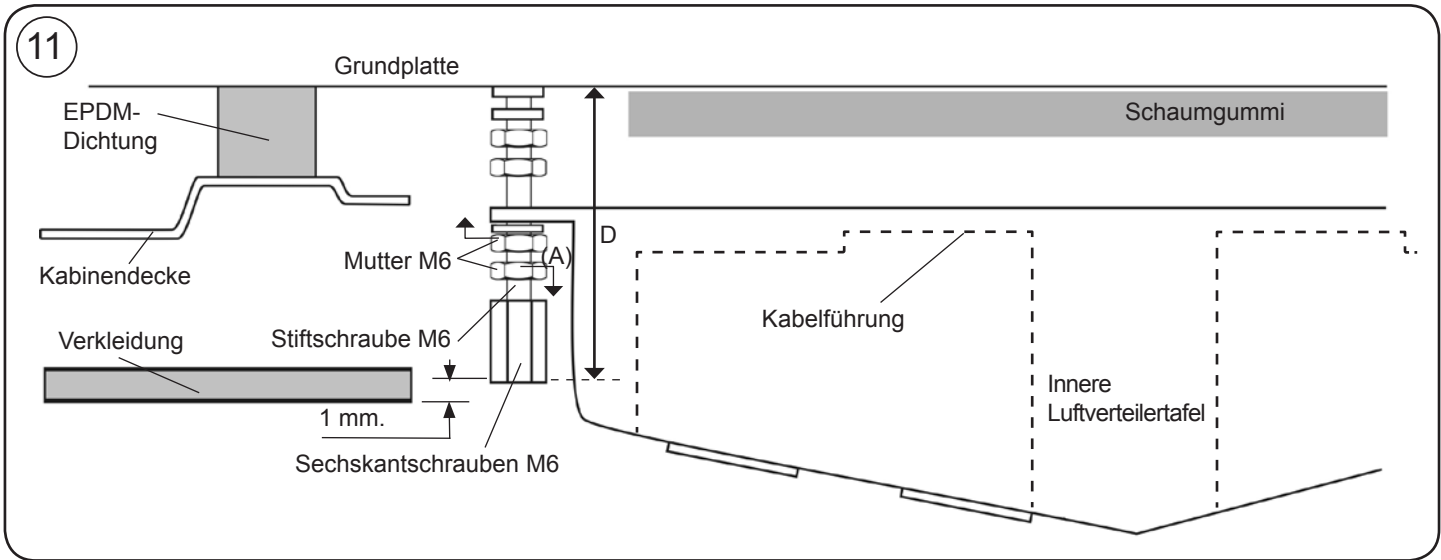

**12** Konsole auflegen und das Gerät zentrieren. Nach dem Zentrieren Konsole entfernen.





13

Die Befestigungshalterungen durch Anziehen der Muttern befestigen, bis der Anzug der äußeren EPDM-Dichtung (Punkt 4) des Geräts zwischen 3 und 6mm liegt; die Dichtung muss noch 19 bis 22 mm dick sein.

**Wichtiger Hinweis:** Um evt. Eindringen von Wasser in das Kabineninnere zu vermeiden, muss sichergestellt sein, dass die EPDM-Dichtung wie im Schema angegeben fest auf der Gerätegrundplatte aufliegt.

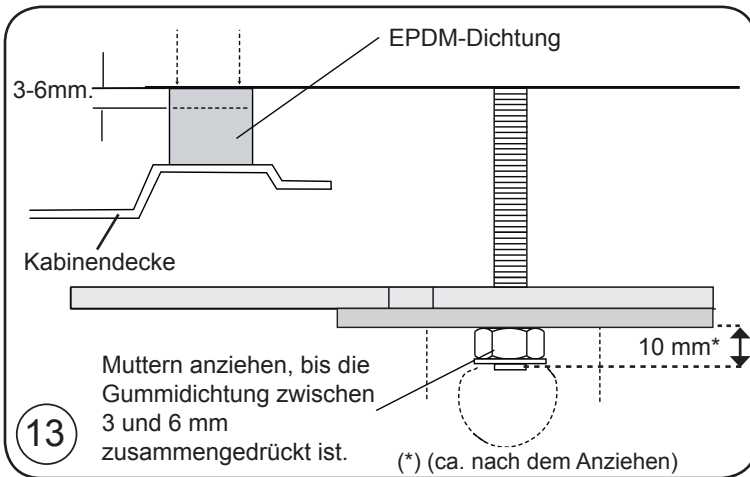

14

(4) Muttern M8 an der Halterung und (4) an der Gerätegrundplatte anziehen.

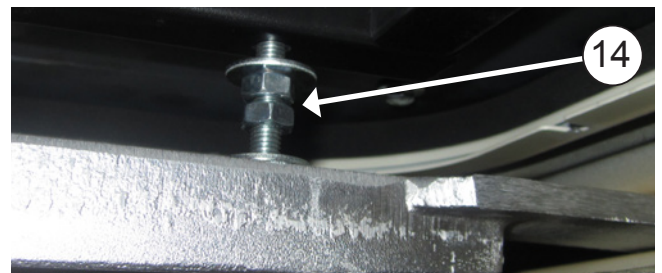



**15** Abluftsensor an der am Lufteinlass angebrachten Klemme anschließen.

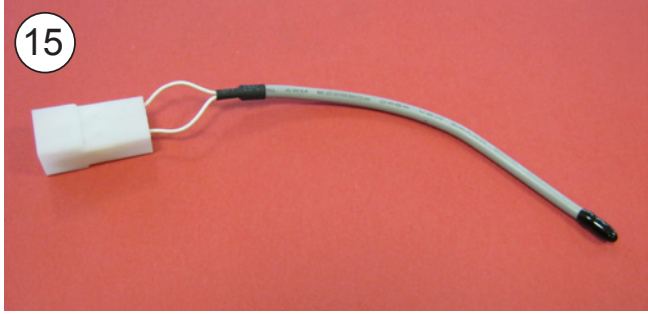

**16** Eine Mutter M6(A) hinter der Befestigungsmutter der inneren Luftverteiltertafel an allen Stiftschrauben anbringen. Sechskant-Verbindungsmuttern M6 eindrehen, bis sie 1 mm über dem Bezug herausstehen. Muttern M6 (A) dieses Punkts herausschrauben, bis sie an den Sechskant-Verbindungsmuttern anstoßen, und gegen diese anziehen.

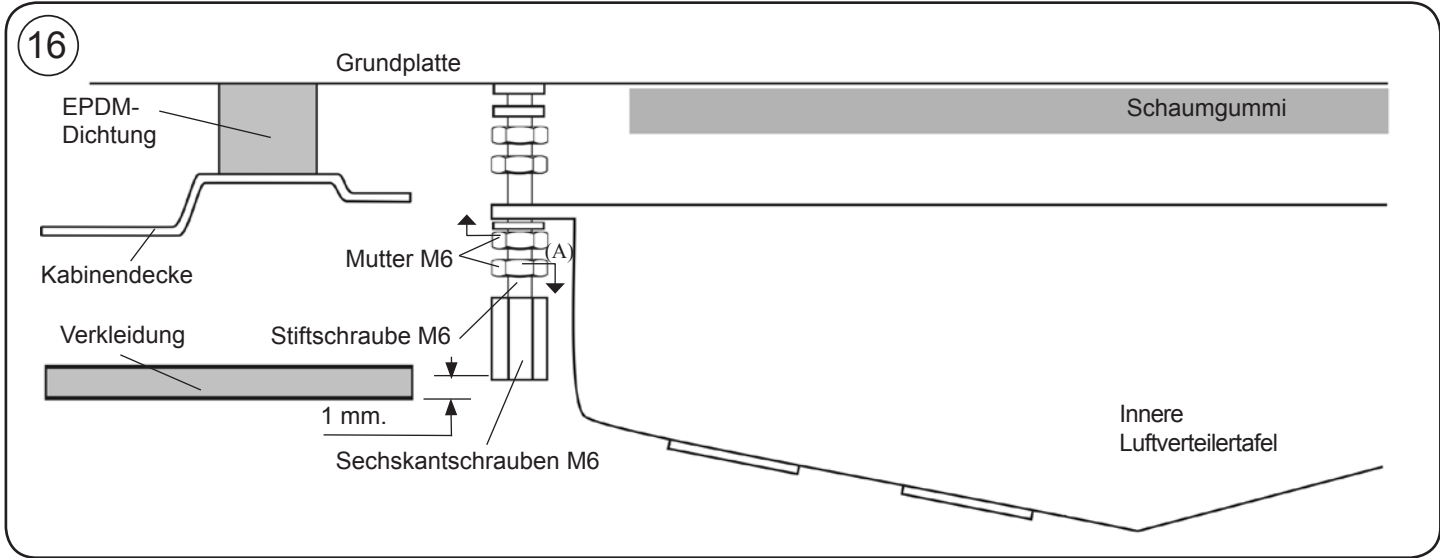
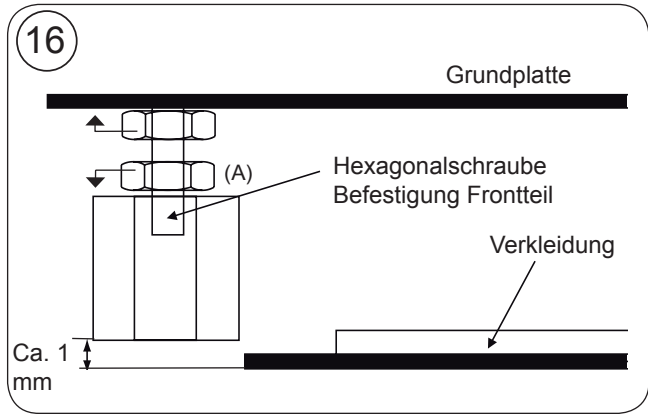

**17** Konsole anhand von (4) Innensechskantschrauben M6/100x15 anbringen.

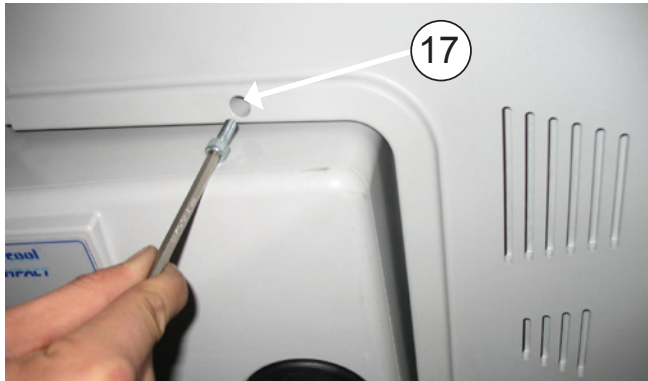

**18** **Achtung:** Die Rückführsonde muss wie angegeben angebracht sein, damit die Kabineninnentemperatur gemessen wird.



**19** Die (4) Innensechskantschrauben M6/100x15 mit den runden Kunststoff-Zierkappen abdecken.



**ENTWÄSSERUNGSROHRE****1**

(4) Ventile in die Entwässerungsrohre einbauen.

**2**

Mit (4) Rohrschellen und (4) Schrauben wie gezeigt befestigen.

**3**

Sicherstellen, dass sie am Kabinendach genug Platz haben und nicht verstopfen können.



**Detaillierte Anleitung für die Installation der Netzkabel**

**4** Das obere Netzkabel an der Gerätehinterrseite anschließen und an der Kabinenrückseite unter Ankleben der Kunststoffhalterungen und Befestigung durch Kabelbinder entlang führen.

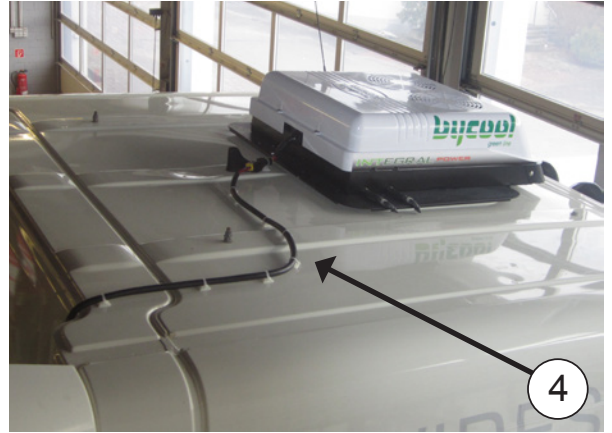
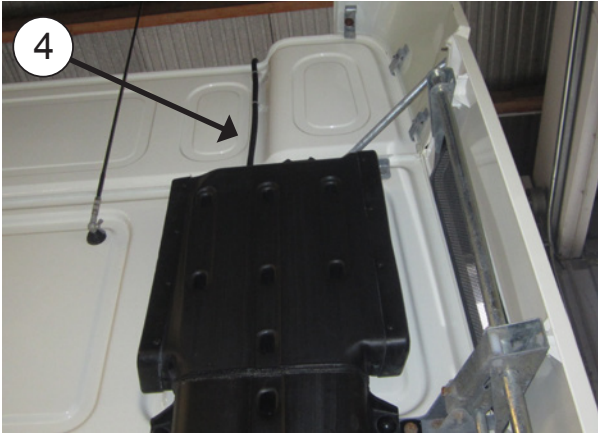

**5** Das untere Netzkabel an der Batterie anschließen, entlang der Original-Kabelführung führen, mit Kabelbindern befestigen, zur Kabinenhinterseite führen und dort an das obere Netzkabel anschließen.

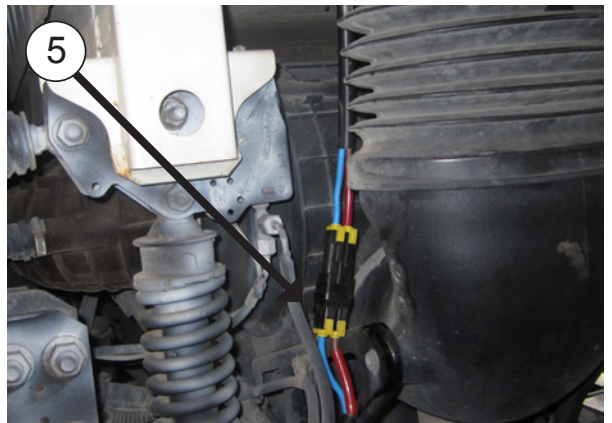
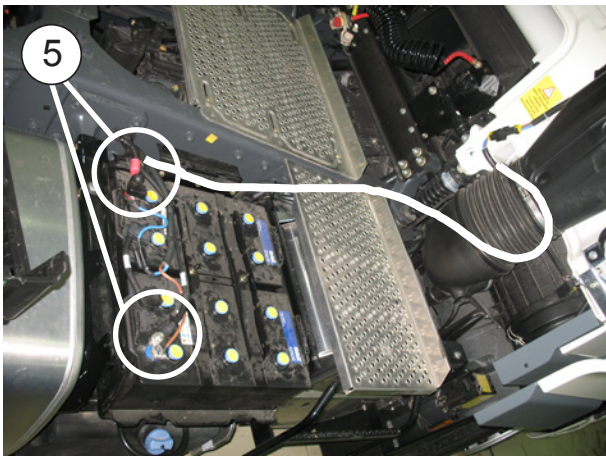



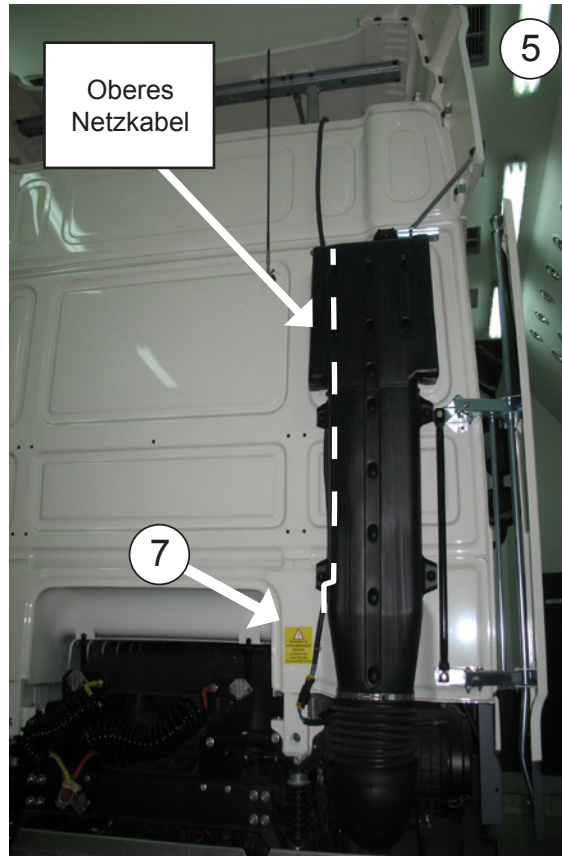

 **Wichtiger hinweis:** Beim anschliessen der kabel zum vermeiden von schäden durch die kabinenbewegungen ausreichend spielraum lassen.

**6** **Wichtiger hinweis:** Aufgrund der komplizierten elektronischen Steuerung des Geräts muss die Stromversorgung direkt an der Fahrzeugbatterie erfolgen.

**Wichtiger hinweis:** Für die Inbetriebnahme sehen Sie bitte im Benutzerhandbuch nach.

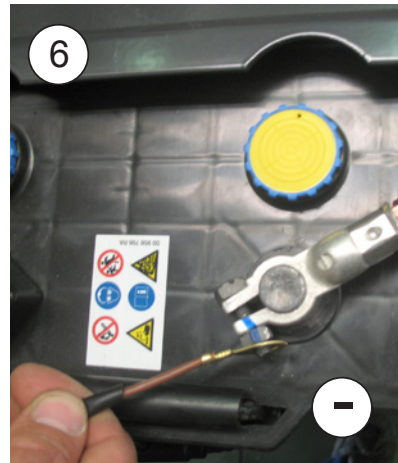
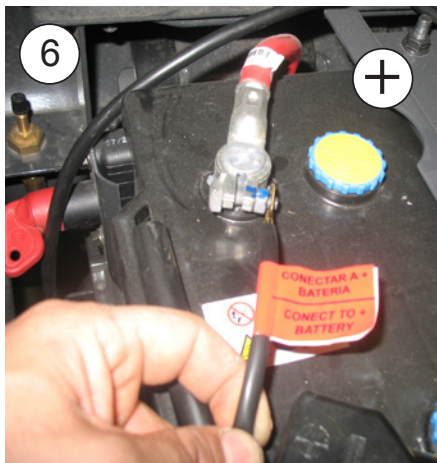

**7** Gefahrenhinweise an Kabelverbindung und Kabinenhebevorrichtung anbringen.

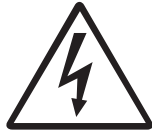

**Alternatoranschlussverkabelung für den Betrieb des Geräts bei laufendem Motor**

 **Achtung:** Die Kabel in allen Fahrzeugen installieren, damit das Gerät bei laufendem Motor funktioniert.

**8** Erregerkabel von innen oder außen her verlegen und Front mit den mitgelieferten Blechschrauben befestigen. Schalter wie gezeigt anschließen.

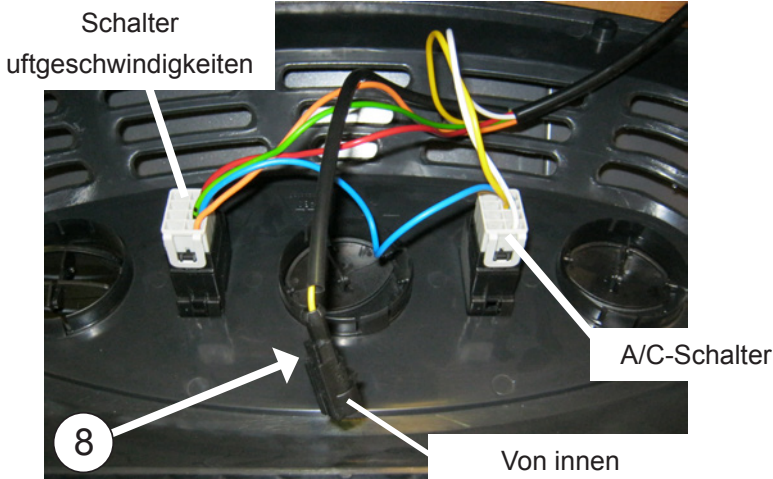
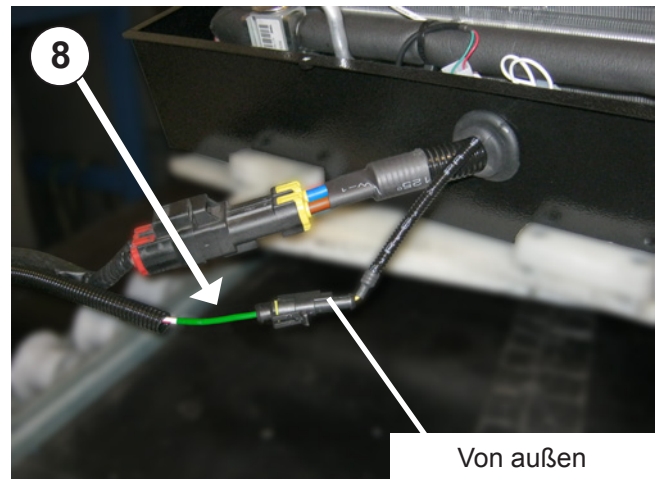

**9**

Das andere Ende des mitgelieferten Kabels in Position (+) nur bei laufendem Motor oder über (+) Kontaktschlüssel anschließen.

**10**

Oberes Stromkabel an der Hinterseite des Geräts anschließen.

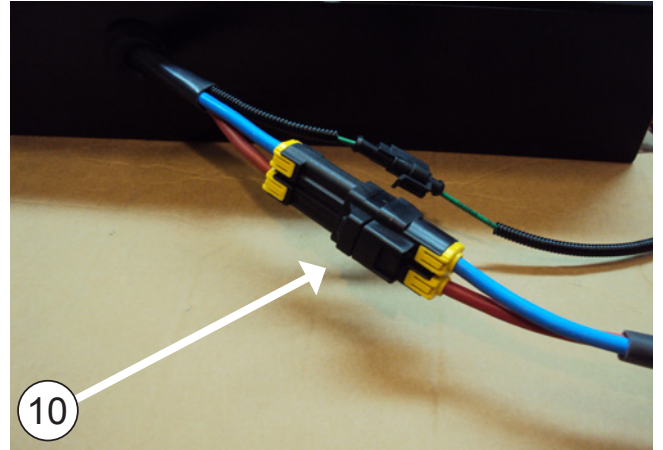

Elektrische Verkabelung

Az	Blau
N	Schwarz
R	Rot
V	Grün
B	Weiss
A	Gelb
Na	Orange
M	Braun

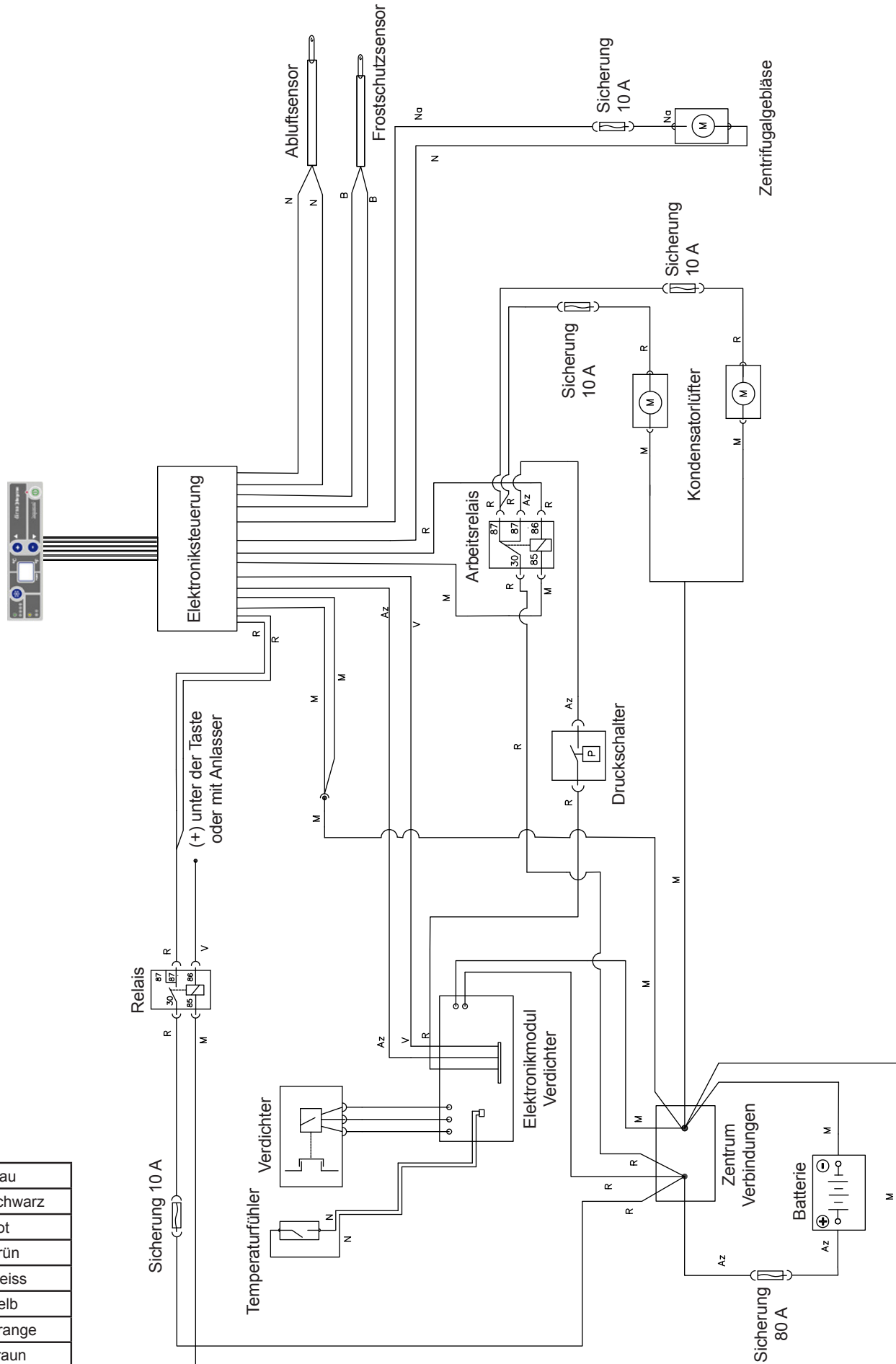





## Suggerimenti per il montaggio

- Prima di cominciare il montaggio, leggere attentamente le istruzioni e rispettarle nel corso dello stesso.
- Usare gli attrezzi più adatti ad ogni operazione.

## Elettricità

- Scollegare la chiave di contatto.
- Scollegare la batteria prima di cominciare il montaggio.
- Assicurarsi di avere effettuato correttamente l'installazione e il collegamento dei componenti elettrici.

## Attenzione

Se durante il montaggio si inclina l'impianto, prima di rimetterlo in funzione occorre attendere almeno 60 minuti dal momento in cui è di nuovo in posizione orizzontale.

## Attenzione

Quando si installa l'impianto di aria condizionata sul tettuccio, bisogna proteggere la parte superiore della cabina con uno straccio o una coperta per evitare eventuali graffi. Per l'installazione del **Integral Power II**, tenere presente che normalmente le cabine munite di oblò dispongono di una struttura abbastanza solida per sostenere il peso dell'impianto. Tuttavia, se così non fosse e se fosse necessario tagliare il tettuccio, o se in presenza di oblò la struttura non fosse abbastanza rigida (se fosse di fibra, plastica, ecc.), è responsabilità dell'installatore decidere se occorre rinforzare il tettuccio per evitare qualsiasi deformazione, rottura o penetrazione d'acqua, ecc., prendendo le misure necessarie per evitarlo.

**Prendere le misure necessarie con le cabine dal tettuccio in plastica e appoggiare solo sui costoloni della cabina per evitare lo sfondamento del pezzo in fibra.**

## Attrezzi

Kit di chiavi Torx

Kit di chiavi Allen

Chiave fissa 13

Forbici

Metro a nastro

## Documenti correlati

Istruzioni di montaggio 1002597509

Guida dell'utente 1002192411

Soluzione dei problemi 1002192414

Elenco ricambi 1002597510

## Documentazione allegata all'impianto

Guida veloce 1002455105

Garanzia 220AA10017

## Simbologia



Fragile



Attenzione alle mani



Tensione elettrica pericolosa

## Avvertenze



L'installatore deve essere in possesso della formazione necessaria in materia di aria condizionata per veicoli.



**Bergstrom** declina ogni responsabilità per danni o rotture derivanti dall'errata installazione o dall'errato uso dell'impianto o da sostituzioni o modifiche effettuate senza la necessaria autorizzazione per iscritto.



**Impianto precaricato con gas refrigerante R-134. (Non manomettere il circuito di gas refrigerante).**



Vedi la **procedura di garanzia** del prodotto in **Diagnosi dei problemi**.



Vedi la **Guida dell'utente** dell'impianto per il corretto funzionamento del telecomando e del pannello di controllo.



I seguenti documenti devono essere consegnati all'utente una volta conclusa l'installazione: **Guida dell'utente, Garanzia e Diagnosi dei problemi**.



**Attenzione:** peso dell'impianto 52 Kg.

**⚠ Attenzione**

Qualsiasi modifica dei sistemi ROPS / FOPS, come l'esecuzione di saldature o perforazioni nelle parti strutturali, inciderà negativamente sulla capacità di tali sistemi ROPS / FOPS di fornire la protezione richiesta. L'installazione di questo prodotto può incidere sui sistemi ROPS / FOPS.

Rivolgersi al proprio rivenditore di fiducia per verificare la compatibilità prima di effettuare modifiche o riparazioni. Altrimenti si potrebbe essere annullata la certificazione ROPS/FOPS. Il costruttore dell'impianto di aria condizionata montato sul tettuccio declina ogni responsabilità.

**1** Smontare il portello e gli elementi di fissaggio e consegnarli al cliente (\*).

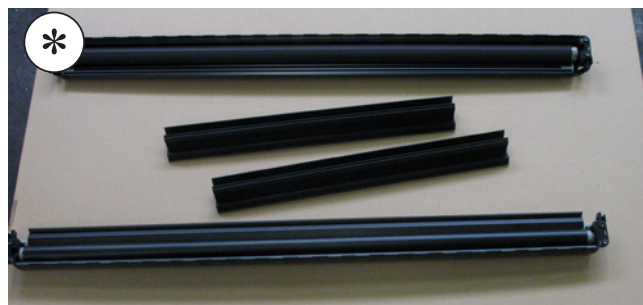

**2** Rimuovere i residui eventualmente rimasti attaccati al tetto prima di incollare la guarnizione EPDM.

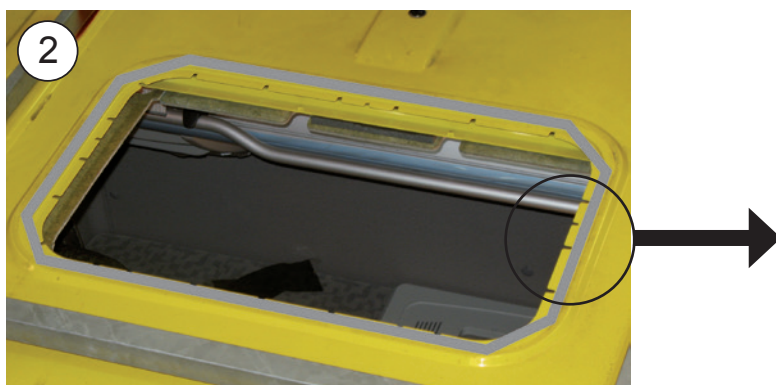

**3** Incollare la guarnizione EPDM intorno al foro dell'oblò (vedi particolare per tagliare i bordi).

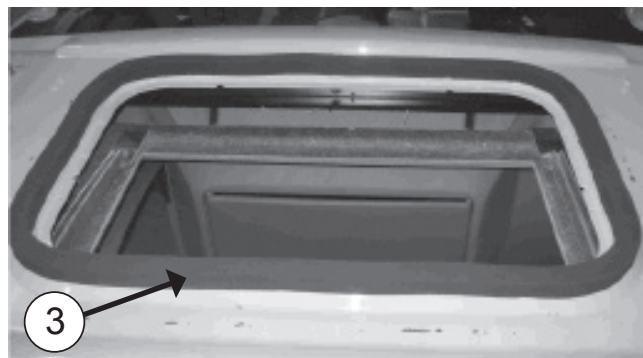

**COME TAGLIARE LA GUARNIZIONE EPDM A PER EVITARE INFILTRAZIONI NELLA CABINA**

- A- Incollare la guarnizione mantenendo una protezione di carta di 100 mm su ogni lato.
- B- Rimuovere i due pezzi di carta.
- C- Incollare premendo su entrambe le estremità.

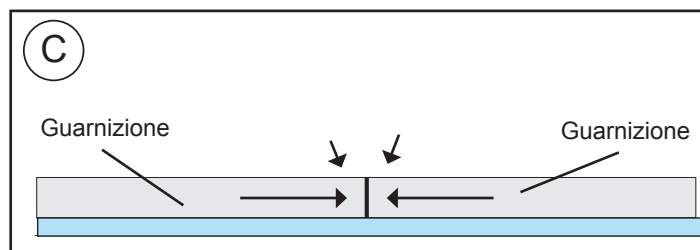
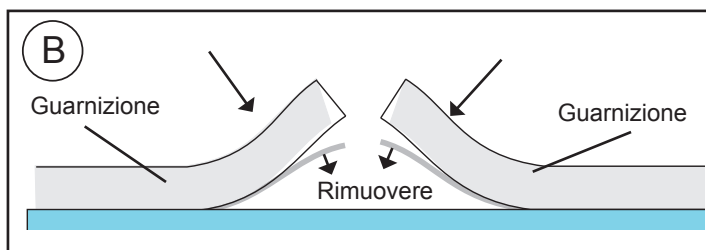
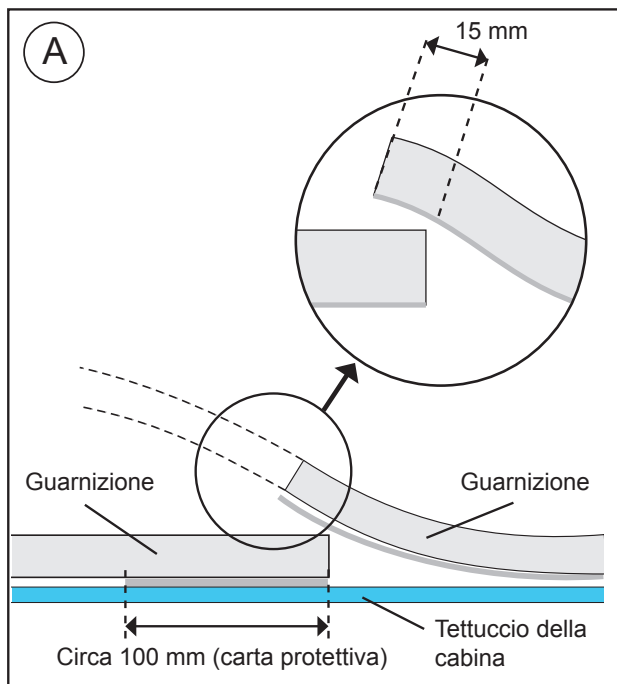

**Nota bene:** L'impianto **Integral Power II** è dotato di 4 golfari saldati ai lati della base per agevolarne il sollevamento in sicurezza mediante un mezzo meccanico.

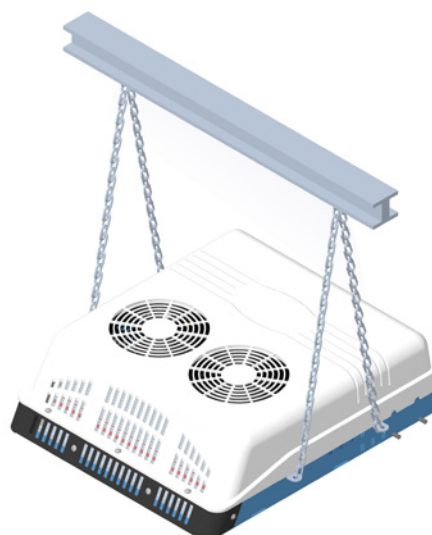
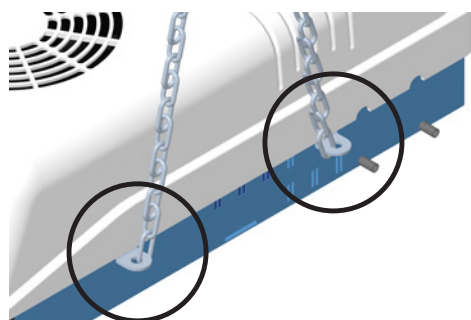



**4** **ESTERNO CABINA:**  
 Inserire l'impianto **Integral Power II** nel vano del tettuccio apribile.

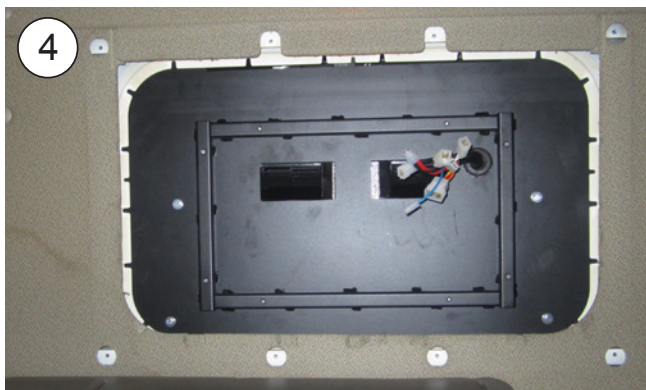

**5** **INTERNO CABINA:**  
 Avvitare di circa 5 mm (4) viti prigioniera 8/125x100-70 o 120 nelle filettature dei rinforzi indicati (\*): la misura va selezionata una volta posizionati i supporti di fissaggio e tenendo conto che le viti prigioniera devono sporgere di circa 20 mm dalla parte inferiore degli stessi.

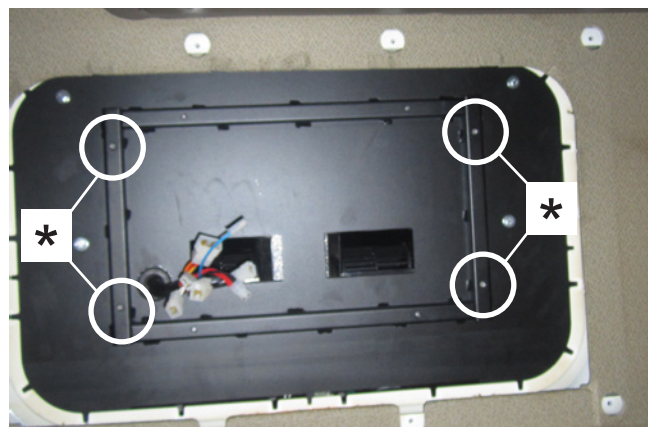
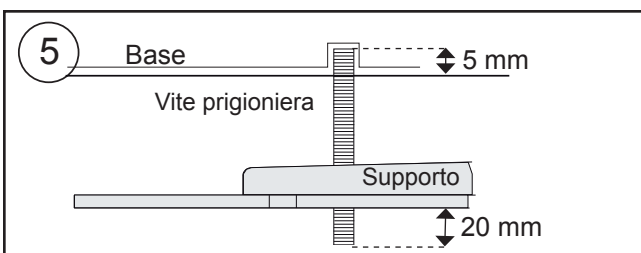

**6** Inserire, nell'ordine: (1) rondella Ø 7 di gomma, (1) rondella piana Ø 8 a testa larga, (2) dadi M8 e (1) rondella piana Ø 8 a testa larga, su ciascuna vite prigioniera precedente.

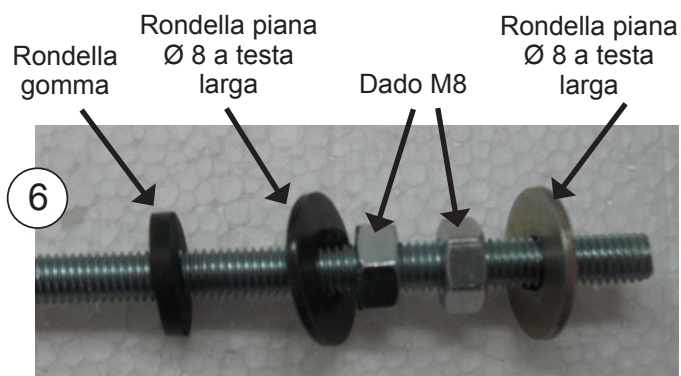

**7** Posizionare (2) supporti di fissaggio, con (4) rondelle e (4) dadi autobloccanti M8, **senza stringere**.

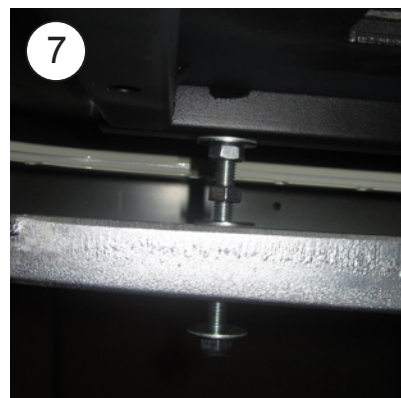
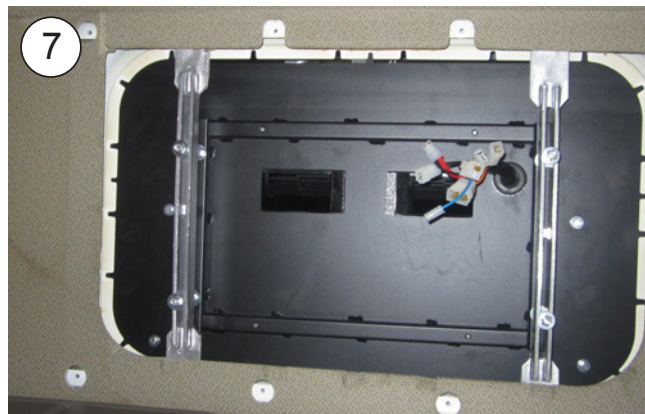

**8** Avvitare di 10 mm (4) viti prigioniera M6 x 55 o 80, nei punti indicati, a seconda della distanza (D) dello schema del punto 11.

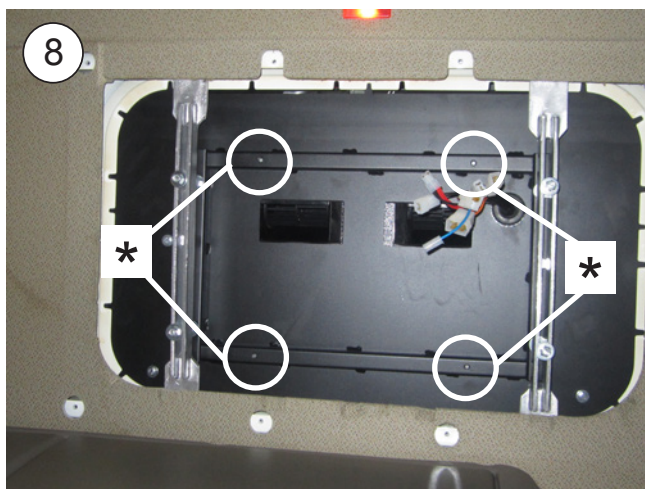

**9** Inserire (1) rondella Ø 6 di gomma, (1) rondella piana Ø 6 a testa larga e (1) dado M6 su ogni vite prigioniera M6. Stringere il dado fino a schiacciare leggermente la rondella di gomma.

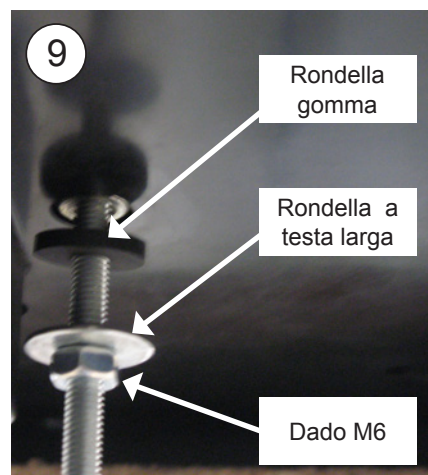

**10** Collegare i cablaggi dell'impianto con quelli del pannello interno di distribuzione dell'aria facendo coincidere le scatole con i colori.

**11** Montare il pannello interno di distribuzione dell'aria sulle viti prigioniera anteriori con (1) rondella M6 a testa larga e (1) dado M6 su ogni vite prigioniera. Stringere i dadi finché i canalizzatori non sono a battuta sulla gommapiuma superiore.

**Nota bene:** i canalizzatori devono essere a battuta contro la gommapiuma per evitare perdite d'aria.

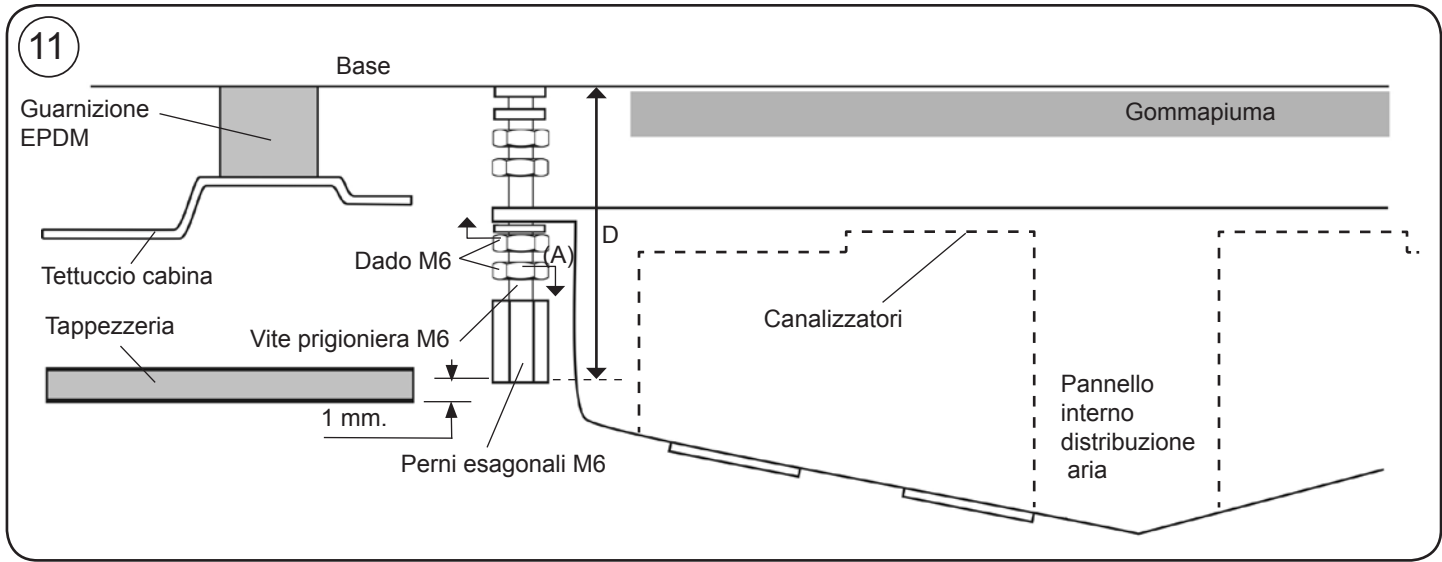

**12** Sistemare provvisoriamente la console e centrare l'impianto. Una volta centrato, rimuovere la console.





**13** Fissare i supporti di fissaggio stringendo i dadi fino a stringere la guarnizione di EPDM esterna (punto 4) dell'impianto tra 3 e 6 mm; la guarnizione deve avere uno spessore compreso tra 19 e 22 mm.

**Nota bene:** per evitare eventuali infiltrazioni d'acqua all'interno della cabina, si deve assicurare il serraggio della guarnizione EPDM con la base dell'impianto come indicato nello schema.

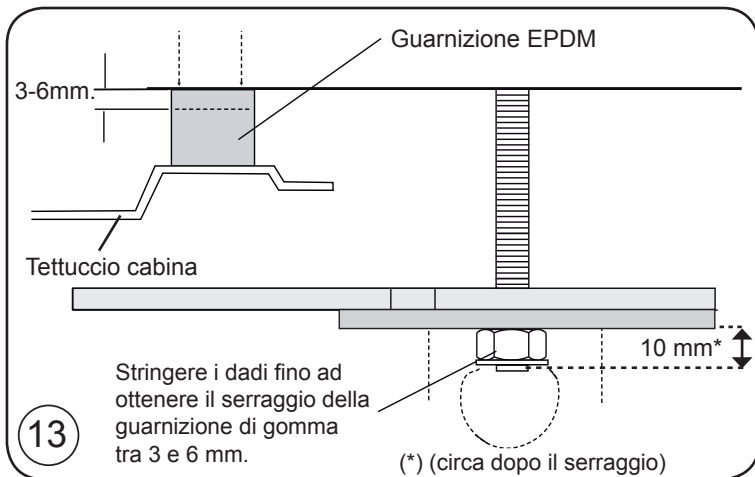
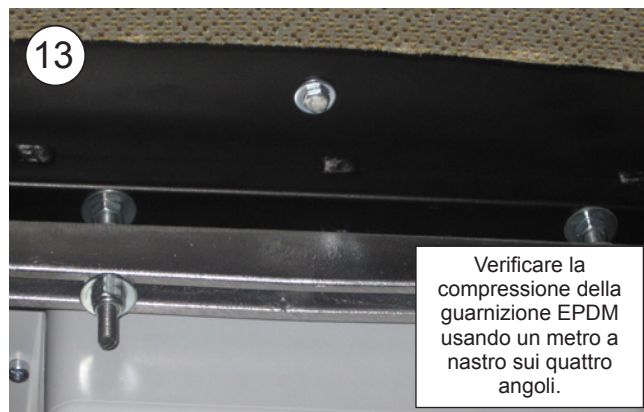

**14** Stringere (4) dadi M8 sul supporto e (4) sulla base dell'impianto.

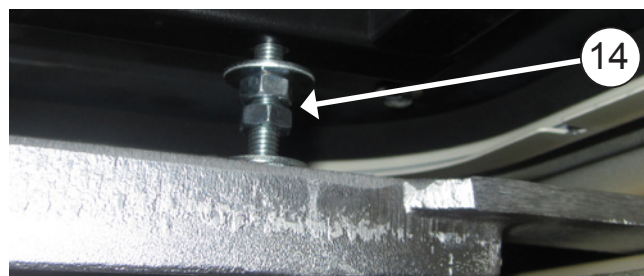



**15** Collegare il sensore dell'aria di ritorno al morsetto situato nel vano di entrata dell'aria.

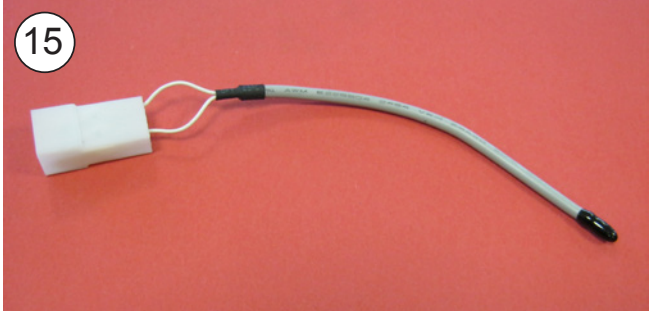

**16** Inserire il dado M6 (A) dopo il dado di fissaggio del pannello interno di distribuzione dell'aria su ogni vite prigioniera. Inserire i perni esagonali M6 e avvitarli fino a lasciarli a 1 mm al di sopra della tappezzeria. Svitare i dadi M6 (A) di questo punto fino a battuta con i perni esagonali e stringerli contro gli stessi.

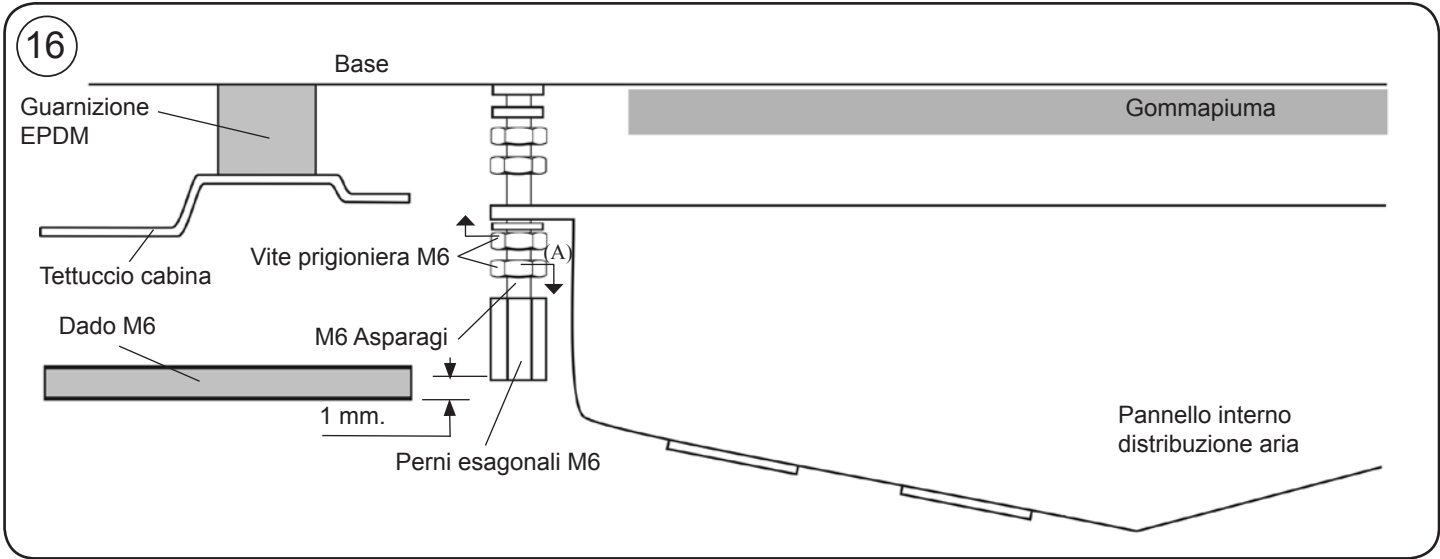
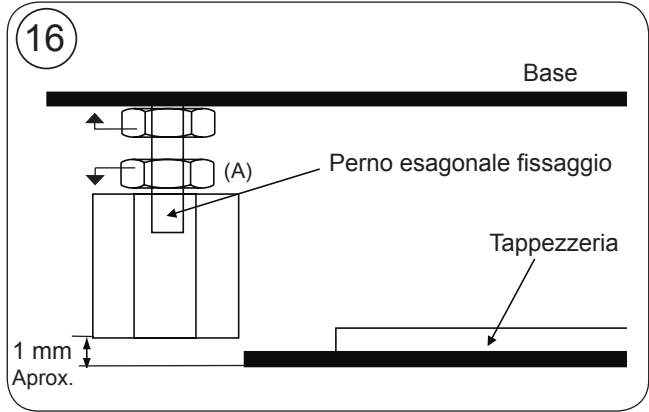

**17** Fissare la console con (4) viti a brugola M6/100x15.

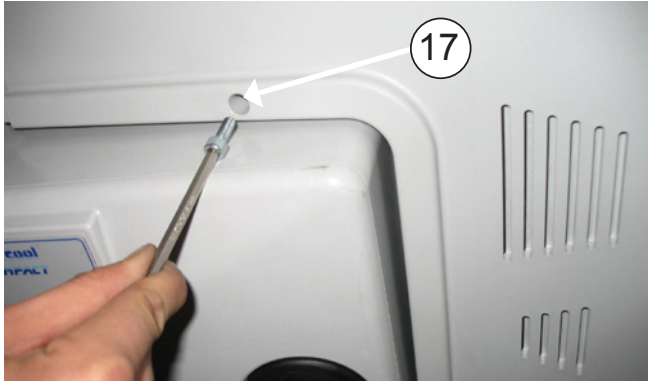

**18** **Attenzione:** La sonda di ricirolo de essere posizionata come indicato per poter acquisire la temperatura all'interno della cabina.



**19** Coprire (4) viti a brugola M6/100x15 con i tappini decorativi M6 di plastica.



**TUBI DI SCARICO**

**1** Montare (4) valvole sui tubi di scarico.



**2** Fissare con (4) fissacavi e (4) viti come indicato.



**3** Verificare che non interferiscano con il tettuccio della cabina, per evitarne l'intasamento.



## Istruzioni particolareggiate per l'installazione del cablaggio di alimentazione

- 4** Collegare il cavo di alimentazione superiore sulla parte posteriore dell'impianto e farlo passare dalla parte posteriore della cabina incollando i supporti di plastica e fissandolo con le fascette.

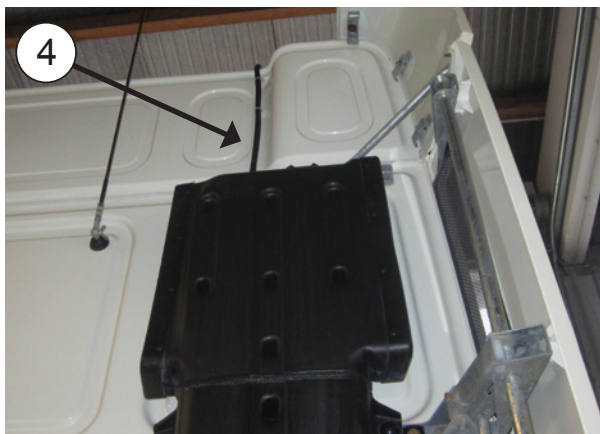

- 5** Collegare il cavo di alimentazione inferiore alla batteria, conducendolo dal passaggio originale dei cablaggi, fissato con le fascette, verso la parte posteriore della cabina, per il collegamento con il cavo di alimentazione superiore.





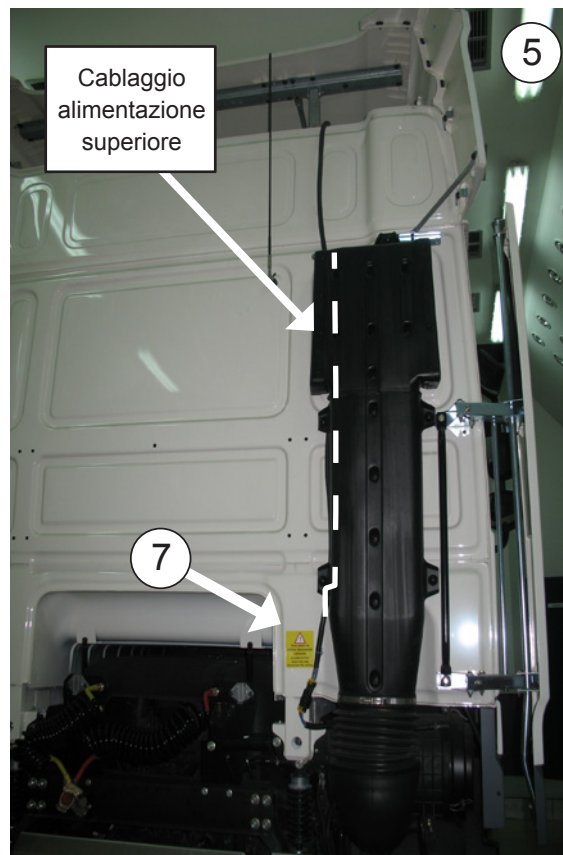

**Nota bene:** quando si collegano i cablaggi, lasciare la distanza necessaria per evitarne la rottura per i movimenti della cabina.

6

**Nota bene:** Dato il complesso sistema di regolazione elettronica dell'impianto, la corrente deve essere presa direttamente dalla batteria del veicolo.

**Nota bene:** Per l'avviamento, vedi il Manuale dell'utente.

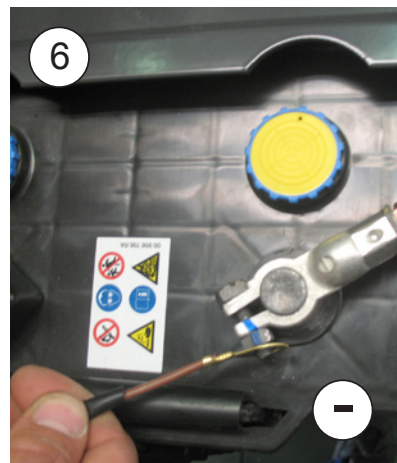

**7** Posizionare gli adesivi indicanti pericolo sulla connessione del cablaggio e sul dispositivo di sollevamento della cabina.



**Cablaggio di connessione all'alternatore o sotto la chiave di accensione per il funzionamento dell'impianto con il motore in moto**

 **Attenzione:** In tutti i veicoli il cablaggio si installa per fare funzionare l'impianto con il motore in moto.

**8** Inserire il cablaggio d'innesto dall'interno o dall'esterno del veicolo a seconda di quanto sia più comodo e montare il frontalino con le viti per lamiera in dotazione. Collegare gli interruttori come indicato.

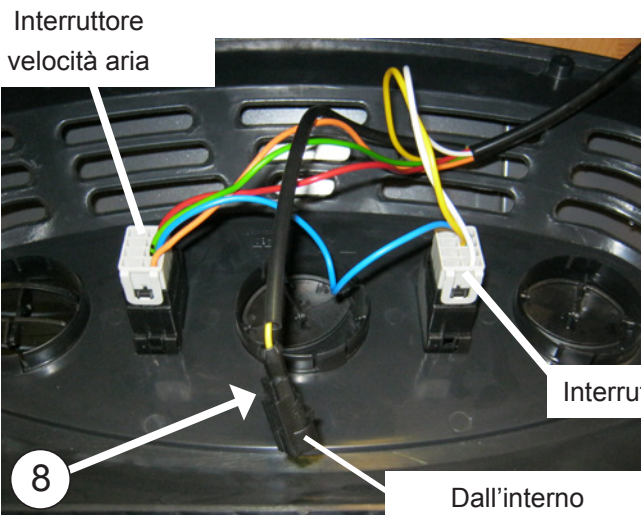
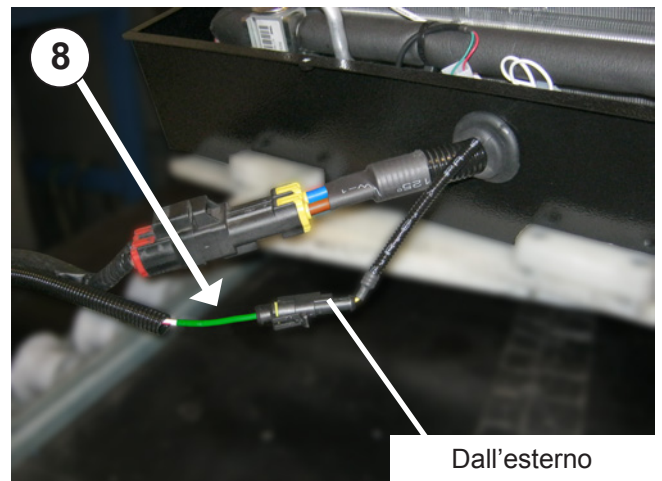

**9**

Collegare l'altra estremità del cablaggio in dotazione in posizione (+) solo con il motore in moto o tramite (+) la chiave di accensione.

**10**

Collegare il cavo di alimentazione superiore alla parte posteriore dell'impianto.

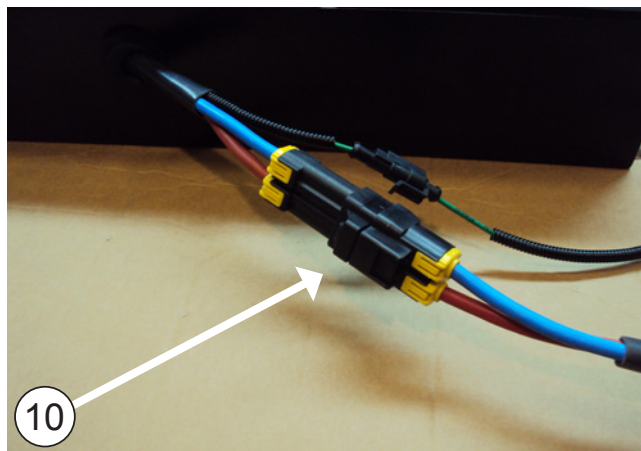

Cablaggio elettrico

Az	Blu
N	Nero
R	Rosso
V	Verde
B	Bianco
A	Giallo
Na	Arancione
M	Marrone

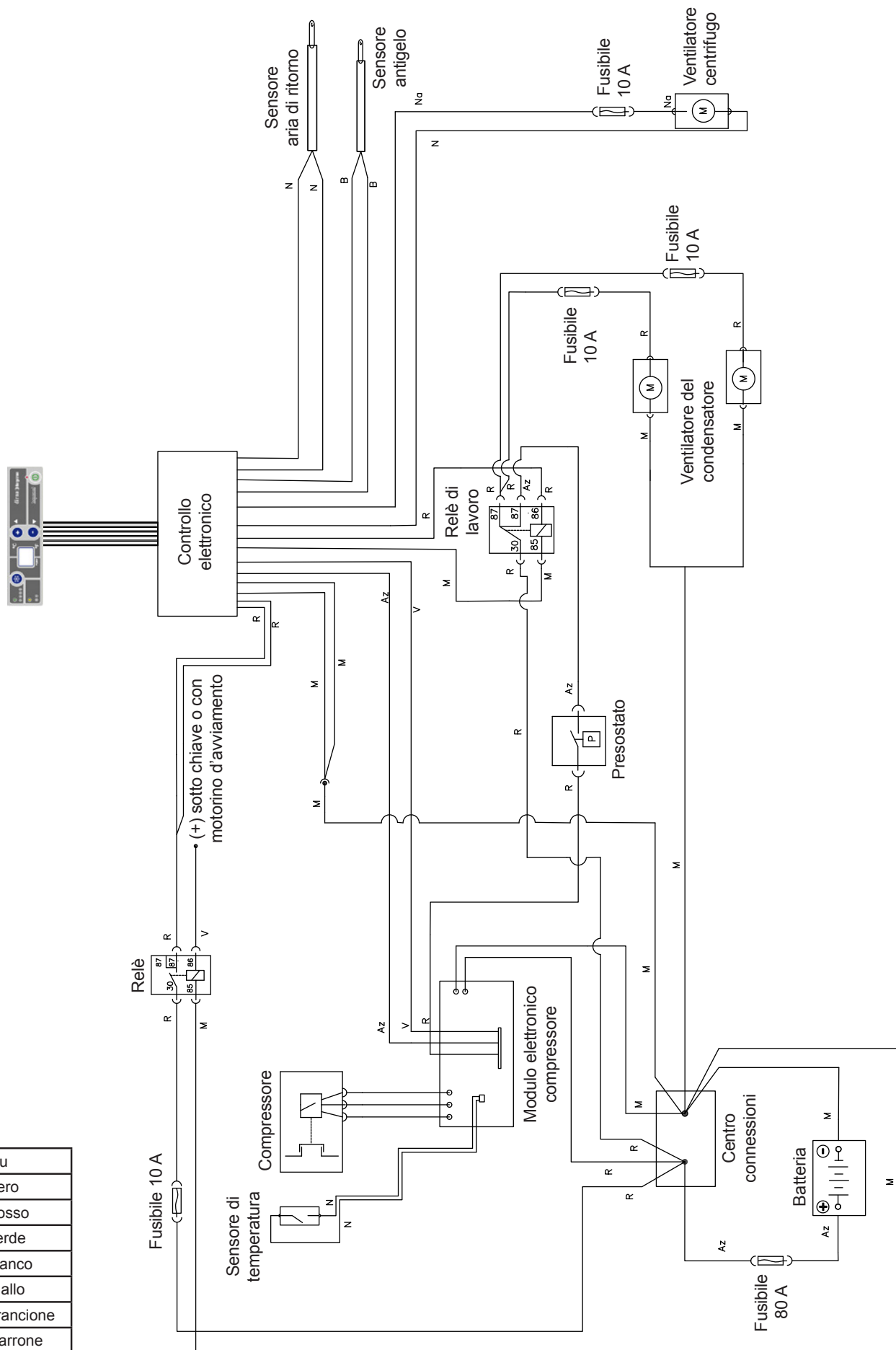



A series of horizontal dotted lines spanning the width of the page, providing a template for writing or drawing.



A series of horizontal dotted lines spanning the width of the page, providing a template for writing or drawing.



Francisco Alonso, 6  
28806 Alcalá de Henares, Madrid  
SPAIN

Ed:	23/01/2020
Md:	26/10/2020

b

Contact	Phone	Fax	E-Mail
Sales (Ventas Internacional)	+34 91 8770510	+34 91 8771158	sales@dirna.bergstrominc.com
Comercial Nacional	+34 91 8775841	+34 91 8836321	ventas@dirna.bergstrominc.com
Orders & Deliveries (Logística internacional)	+34 91 8775846	+34 91 8771158	export@dirna.bergstrominc.com
Orders & Deliveries (Logística nacional)	+34 91 8775840	+34 91 8836321	comercial@dirna.bergstrominc.com
Technical Assistance (Internacional)	+49 511 86679681	+49 511 86679710	technicalassistance@dirna.bergstrominc.com
Technical Assistance (Nacional)	+34 91 8775845	+34 91 883 6321	oblanco@dirna.bergstrominc.com

[www.dirna.com](http://www.dirna.com)

	<b>ATENCIÓN:</b>	Bergstrom se reserva el derecho de efectuar modificaciones en cualquier momento de los datos contenidos en esta publicación, por razones técnicas o comerciales.
	<b>NOTE:</b>	<i>For technical and commercial reasons, Bergstrom reserves the right to change the data contained in this brochure.</i>
	<b>ATTENTION:</b>	Bergstrom se réserve le droit d'effectuer à tout moment des modifications des données reprises sur cette publication, pour des raisons techniques ou commerciales.
	<b>HIWEIS:</b>	<i>Bergstrom behält sich vor, aus technischen oder kaufmännischen Gründen jederzeit Änderungen der Angaben dieser Veröffentlichung vorzunehmen.</i>
	<b>ATTENZIONE:</b>	Bergstrom si riserva il diritto di effettuare modifiche in qualsiasi momento ai dati contenuti in questa pubblicazione, per motivi tecnici o commerciali.